

ALWAYS
THE BEST
**PROTECTION
PROFILES**



SPAT
COMMITMENT TO EXCELLENCE

DISTRIBUTOR OF MPM s.r.l.

JUNE 2020



PRESENTS NEW MATERIAL



CONTENTS



page 02

01	Rack Protection	page 08	08	BFlex	page 50
02	Bollard	page 16	09	Column Protection	page 58
03	Guard Rails	page 20	10	Loading Bays Protections	page 64
04	Cold Line	page 26	11	Corner Protection	page 66
05	Pedestrian Safety Barriers	page 32	12	Kerb	page 68
06	Doors	page 38	13	Wall Protection	page 72
07	Link	page 44			



OUR **PENDULUM MACHINE** FOR CRASH REPORTS

RESEARCH AND DEVELOPMENT
CUSTOMISED PROJECT MANAGEMENT SERVICE

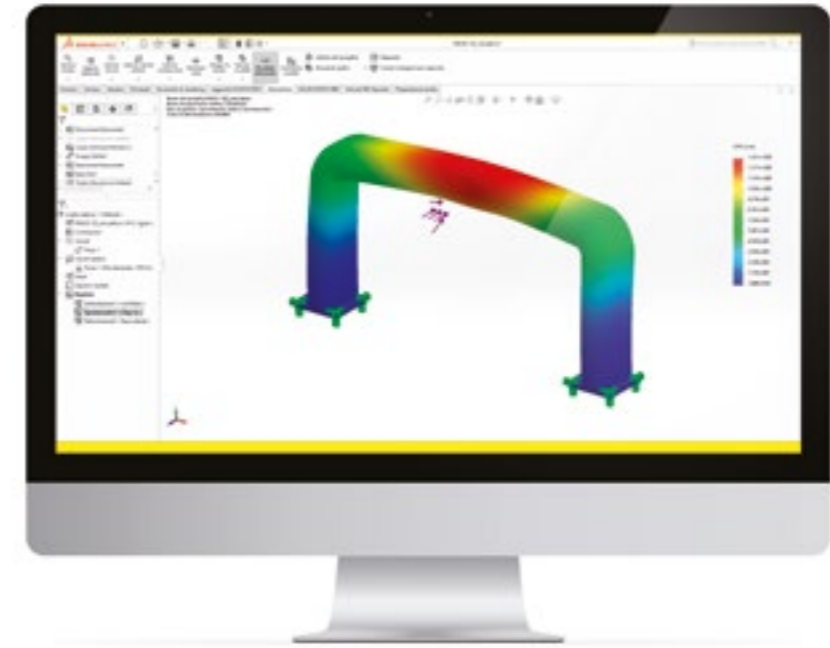



FIRE CLASS V0,
SELF-EXTINGUISHING,
NON-FLAME SPREAD
MATERIAL

RESEARCH AND DEVELOPMENT NEVER STOP!

ORANGE LINE





AVAILABLE FOR:
LM / PED 150 /
TOWER



**HIGHER
VISIBILITY
FOR A GREATER
SAFETY!**

FOR FLEXIBLE BARRIER

PROTECTION ARE THE BEST CHOICE IN COMPARISON TO METAL OR OTHER MATERIALS

		METAL	PE/PP	WOOD
				
EASY CLEANING	● ● ● ● ●	● ● ● ● ○	● ● ○ ○ ○	○ ○ ○ ○ ○
SCRATCHES	● ● ● ● ●	● ● ● ○ ○	● ● ● ○ ○	● ○ ○ ○ ○
FLEXIBILITY	● ● ● ● ●	● ○ ○ ○ ○	● ● ● ● ●	● ● ○ ○ ○
SHOCK ABSORBER	● ● ● ● ●	○ ○ ○ ○ ○	● ● ● ● ○	● ● ○ ○ ○
FAST INSTALLATION	● ● ● ● ●	● ● ● ● ●	● ● ● ○ ○	● ● ● ● ○
SAVE SPACE	● ● ● ● ○	● ● ● ● ●	● ● ○ ○ ○	● ● ● ○ ○
FIRE RESISTANT	● ● ● ● ○	● ● ● ● ●	○ ○ ○ ○ ○	○ ○ ○ ○ ○
LONG LASTING	● ● ● ● ●	● ● ● ● ●	● ● ● ○ ○	● ● ○ ○ ○

RESEARCH AND DEVELOPMENT NEVER STOP!

CLIP 90

NEWS

AVAILABLE FOR:
LM / PED 150 /
TOWER

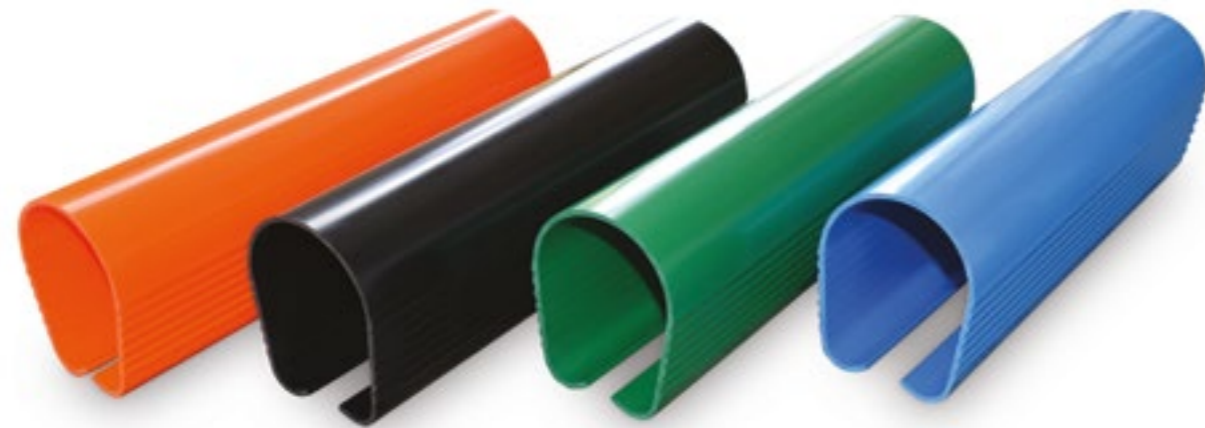

EASY TO
INSTALL



CUSTOMIZE
YOUR BARRIER



MORE
VISIBILITY

GENIUS

THE LENGTH THAT YOU WISH



CUT THE RAIL AND DRILL IT
WITH GENIUS



FOR YOUR
PEDESTRIAN
BARRIERS

FOR YOUR
HUG TOWER



NEW!
DO IT YOURSELF!

WORLD'S UNIQUE SYSTEM!
YOUR CUSTOMIZED BARRIER AND HUG TOWER

SAFETY TOTEM

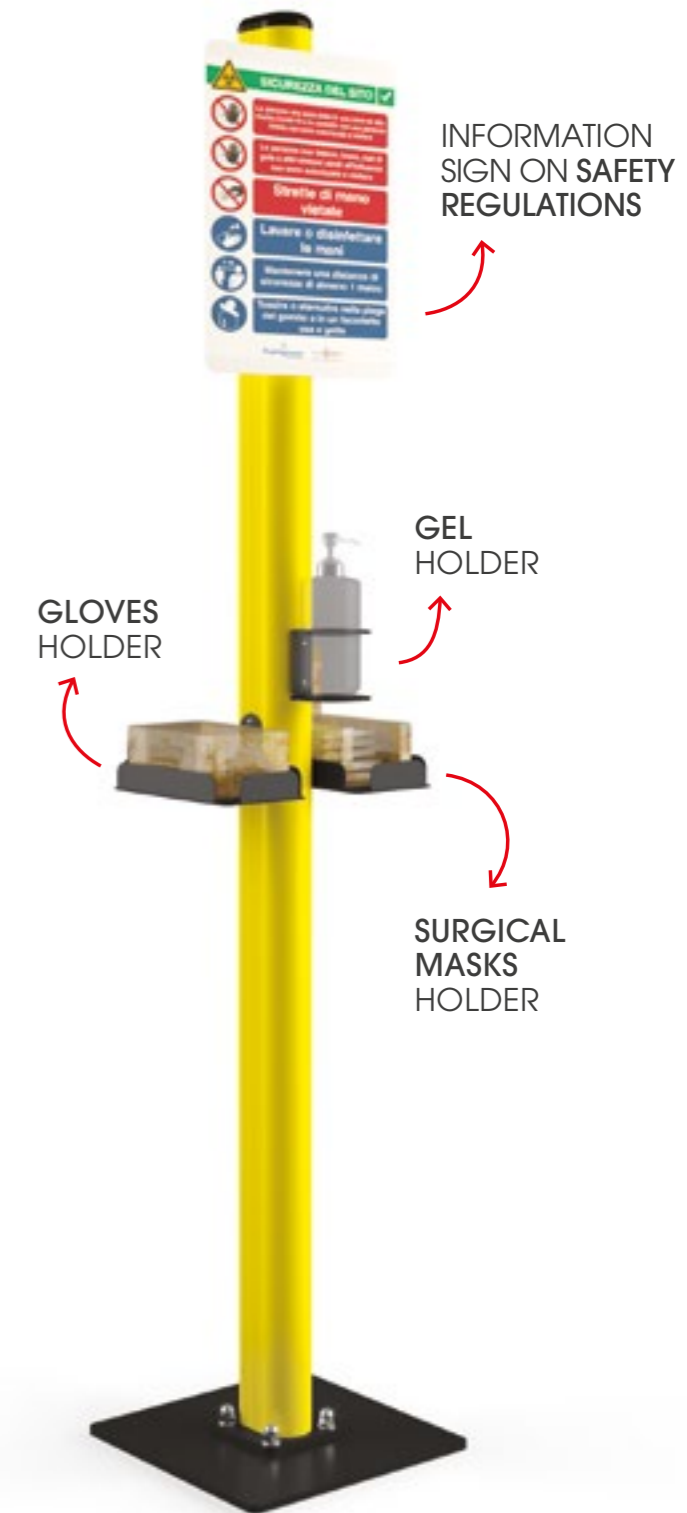

INFORMATION
SIGN ON SAFETY
REGULATIONS

GLOVES
HOLDER

GEL
HOLDER

SURGICAL
MASKS
HOLDER

AVAILABLE IN **FOUR** VERSIONS

01

RACK PROTECTION

OUR PROFILES FIT ALL RACKS

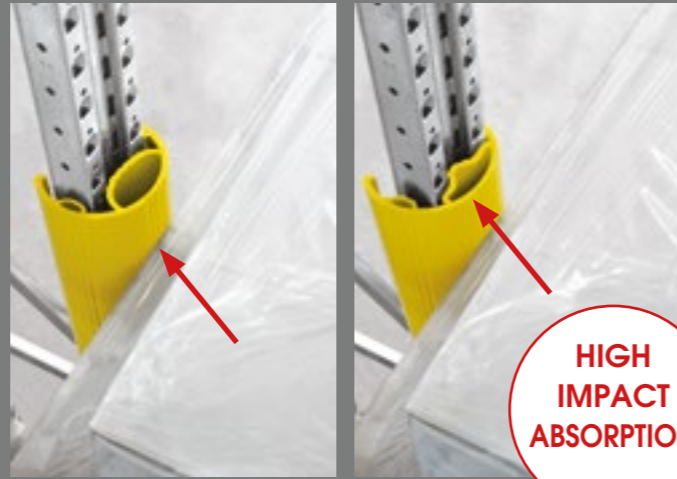

Full range of techno polymer profiles for protection of warehouse racks.

Gamma completa di profili in tecnopolimeri per la protezione di scaffali.

Complète gamme de profilés en tecnopolimère pour la protection d'étagères de dépôts.

Gama completa de perfiles de tecnopolímeros para las protecciones de estanterías.



EASY TO INSTALL

THE ONLY ONE WITH TRIPLE SHOCK ABSORBER

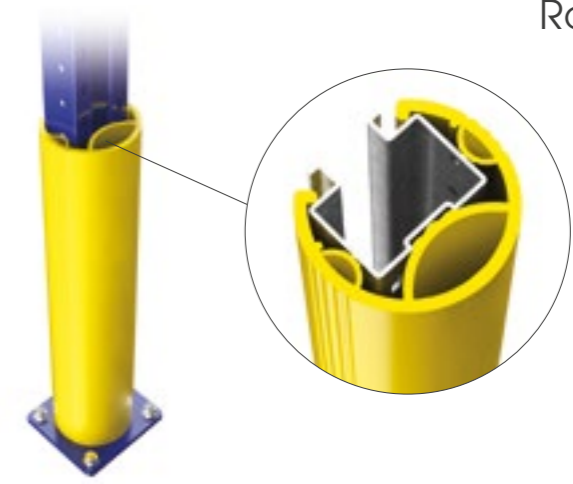

RPS 600

60 80

Available also size 400

ANTISHOCK MATERIAL INSIDE

Packing 6 pz / box
Packing 114 pz / big parcel
Colour M

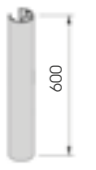

RPM 600

80 100

Available also size 400

ANTISHOCK MATERIAL INSIDE

Packing 4 pz / box
Packing 80 pz / big parcel
Colour M

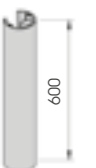

RPL 600

100 120

Available also size 400

ANTISHOCK MATERIAL INSIDE

Packing 2 pz / box
Packing 54 pz / big parcel
Colour M

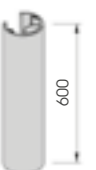

RPL XL 600

100 120

Available also size 400

ANTISHOCK MATERIAL INSIDE

Packing to be defined
Colour M



RP CLICK

Packing 1 pz / box



RPF 600

60 130

Equipped with accessories

FLEXIBLE

Packing 2 pz / bag
Colour M

Axle spacing 25 - 50 - 75 mm

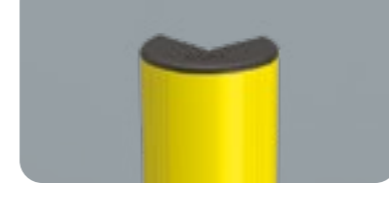

RACK CORNER

ANTISHOCK MATERIAL INSIDE

Packing to be defined
Colour M

Equipped with accessories

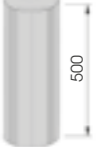

Rack end Barriers

SM



DIFFERENT SIZES ON REQUEST

FAST AND EASY TO INSTALL

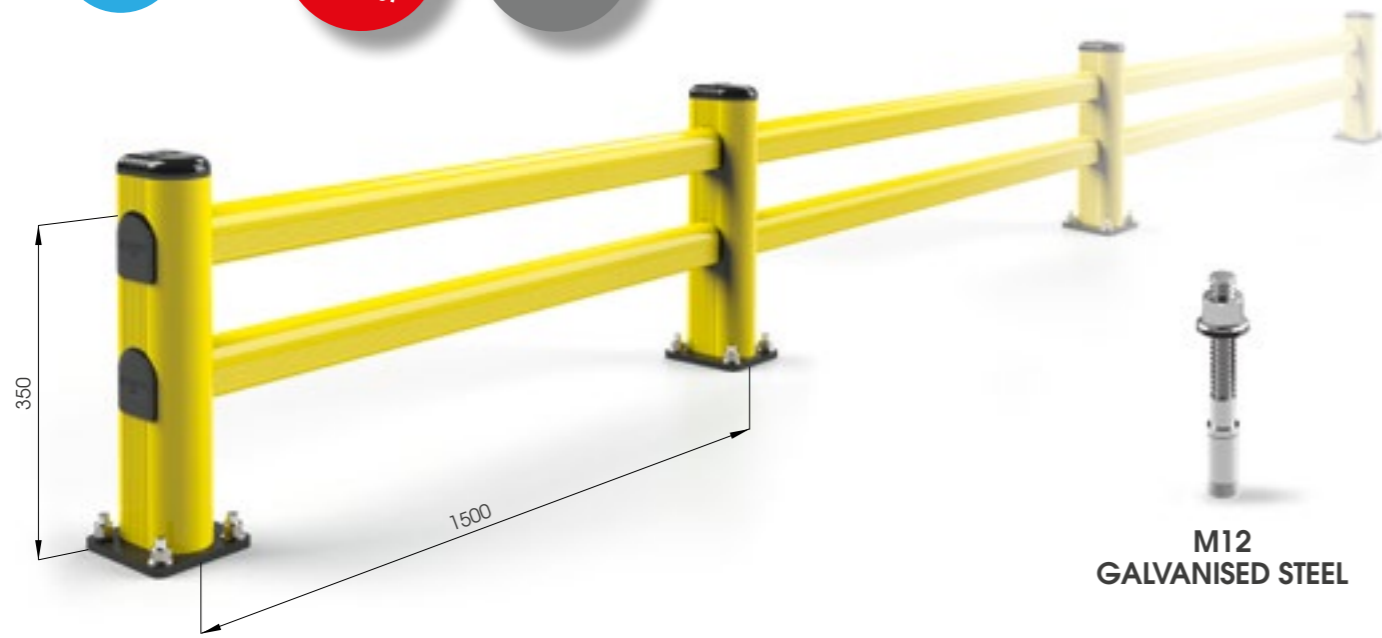

M12 GALVANISED STEEL



SM 1500x400 MODULAR

Packing Colour **B** **M** unpacked on pallet

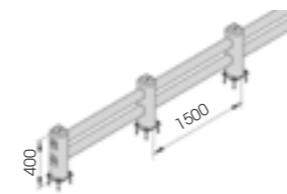

Equipped with accessories



SM 1100x400

Length 1.100 Packing Colour **B** **M** unpacked on pallet

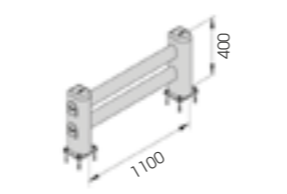

Equipped with accessories



Rack end Barriers

LM



DIFFERENT SIZES ON REQUEST

FAST AND EASY TO INSTALL

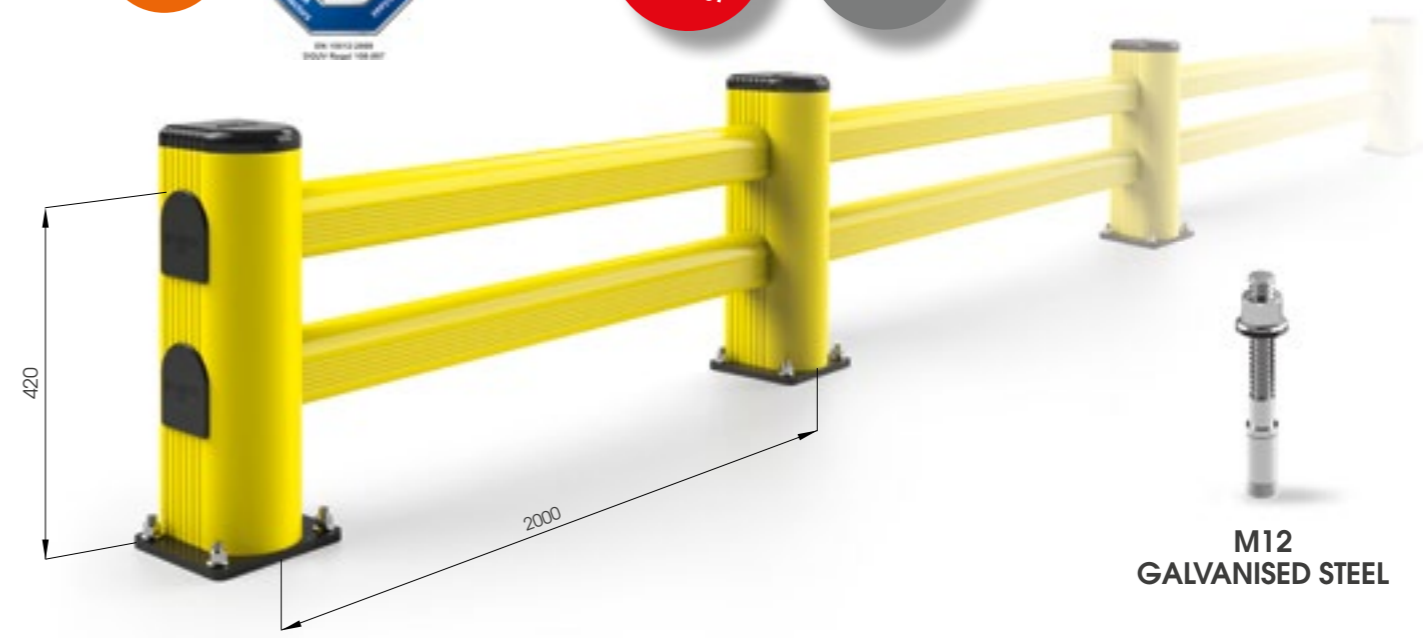

M12 GALVANISED STEEL



LM 2000x500 MODULAR

Packing Colour **B** **M** unpacked on pallet

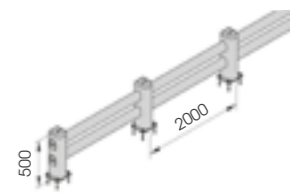

Equipped with accessories



LM 1100x500 LM 2400x500

Length 1.100 / 2.400 mm Packing Colour **B** **M** unpacked on pallet

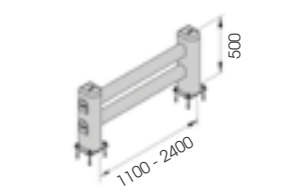

Equipped with accessories



FENCE 90



DIFFERENT SIZES ON REQUEST

FAST AND EASY TO INSTALL



M12 GALVANISED STEEL



FE 90 1100x350

Length 1.100 mm
Packing unpacked on pallet
Colour B M



Equipped with accessories



FE 90 2400x350

Length 2.400 mm
Packing unpacked on pallet
Colour B M



Equipped with accessories



FENCE 150



DIFFERENT SIZES ON REQUEST

FAST AND EASY TO INSTALL



M12 GALVANISED STEEL



FE 150 1100x550

Length 1.100 mm
Packing unpacked on pallet
Colour B M



Equipped with accessories



FE 150 2400x550

Length 2.400 mm
Packing unpacked on pallet
Colour B M



Equipped with accessories



FENCE 150 REINFORCED



DIFFERENT SIZES ON REQUEST

FAST AND EASY TO INSTALL



FE 150 REF 1100x550

Length 1.100 mm
Packing unpacked on pallet
Colour B M



Equipped with accessories



FE 150 REF 2400x550

Length 2.400 mm
Packing unpacked on pallet
Colour B M



Equipped with accessories

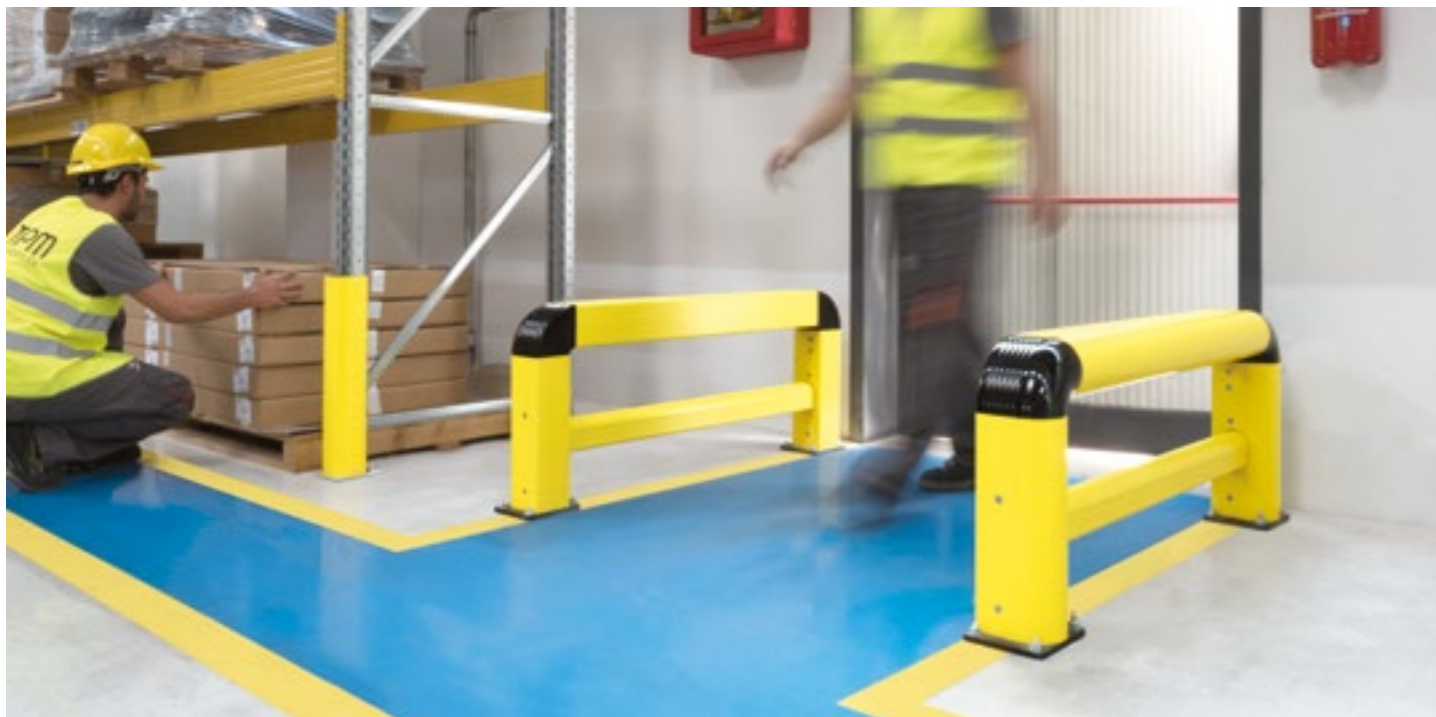

FENCE LINK



DIFFERENT SIZES ON REQUEST

FAST AND EASY TO INSTALL



FE LINK 1100x550

Length 1.100 mm
Packing unpacked on pallet
Colour B M

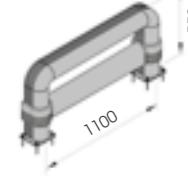

Equipped with accessories

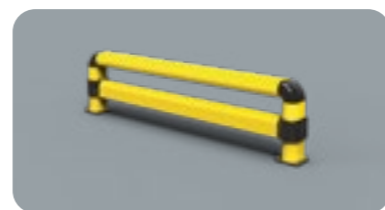

FE LINK 2400x550

Length 2.400 mm
Packing unpacked on pallet
Colour B M

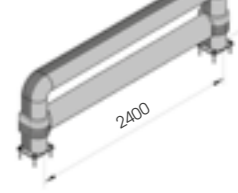

Equipped with accessories



02 BOLLARD

Designed to protect access to gates or big doors from huge traffic or simply to mark restricted areas for pedestrians. Fully equipped with fixing accessories.

Ideato per proteggere l'accesso a cancelli o portoni dalla movimentazione di mezzi pesanti o semplicemente per impedire l'ingresso di pedoni. Provisto di accessori di fissaggio.

Étudié pour protéger l'accès aux portes ou entrées de grand trafic ou simplement pour marquer les zones de passage piétons. Equipé avec les accessoires d'installation.

Diseñado para proteger el acceso a puertas o portones del movimiento de vehículos pesados o simplemente para evitar la entrada de peatones. Provisto de accesorios de fijación.



GRD 90



Bollard

FAST AND EASY TO INSTALL



M12 GALVANISED STEEL



GRD 90 250

Packing Colour **unpacked on pallet**
B M

Equipped with accessories

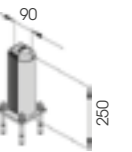

GRD 150



FAST AND EASY TO INSTALL



Bollard



M12 GALVANISED STEEL

GRD 200

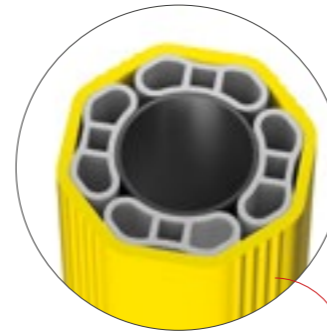

NEW ANTISHOCK BUMPER

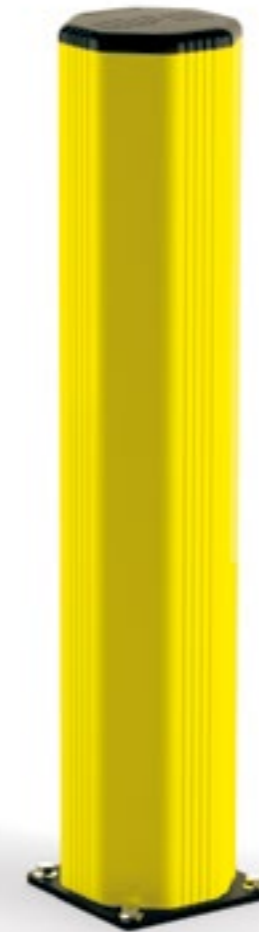

INCLUDED

FAST AND EASY TO INSTALL



S16 GALVANISED STEEL



GRD 150 * 500
800
1150

Equipped with accessories

Packing Colour **B** **M** unpacked on pallet

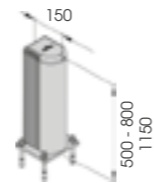

GRD 200 1200
2000

Equipped with accessories

Packing Colour **M** unpacked on pallet



03 GUARD RAILS

Sistema profili antiurto specifico per la protezione delle pareti dai carrelli in movimento. Progettato seguendo un innovativo disegno tecnico che coniuga rapidità e semplicità nelle fasi di installazione e pulizia. Disponibile in diverse lunghezze.

Nouveau système bumper, spécifique pour protéger les murs contre les mouvements des charriots. Étudié avec un modern dessin qui regroupe la rapidité et la facilité pendant l'installation et le nettoyage. Disponible en différents longueurs.

Sistema de perfiles anti-impacto específico para la protección de las paredes de los carros en movimiento. Diseñado según un diseño técnico innovador que une velocidad y simplicidad en las fases de instalación y limpieza. Disponible en diferentes longitudes.

A new bumper system specific for the protection of the walls resistant against trolleys movements. Designed by following an innovative technical design that combines speed and simplicity in the steps of installation and cleaning. Available in different lengths.



TRUCK LINE



DIFFERENT SIZES ON REQUEST



TL	500	2000
	750	3000
	1000	4000
	1500	

Equipped with accessories

Packing Colour to be defined
B M



GUARD RAIL 90



QUICK
INSTALLATION
WITH
EXPANSION
SCREW



M16
GALVANISED STEEL

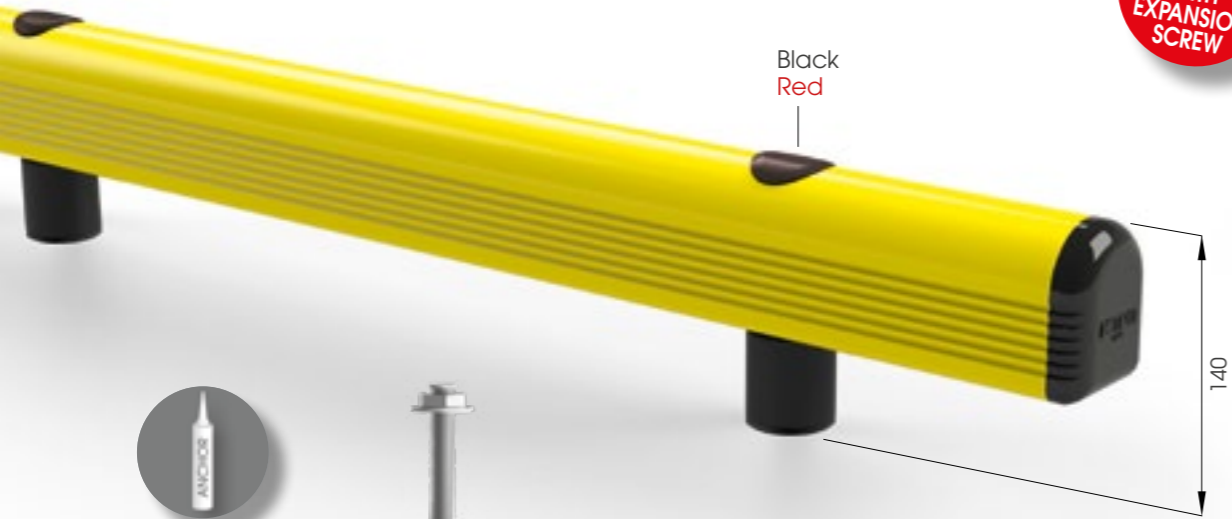

ALTERNATIVE FIXING
HIGH RESISTANCE WITH RESIN
M16
STAINLESS STEEL



GR 90 500
750
1000
1500

Length 500 mm
Packing unpacked on pallet

Length 750 / 1000 / 1500 mm
Packing 2 pz / box

Colour B M

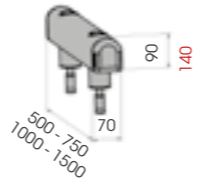

Equipped with accessories



GR 90 2000
3000
4000

Length 2.000 / 3.000 / 4.000 mm
Packing unpacked on pallet

Colour B M

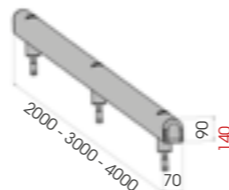

Equipped with accessories

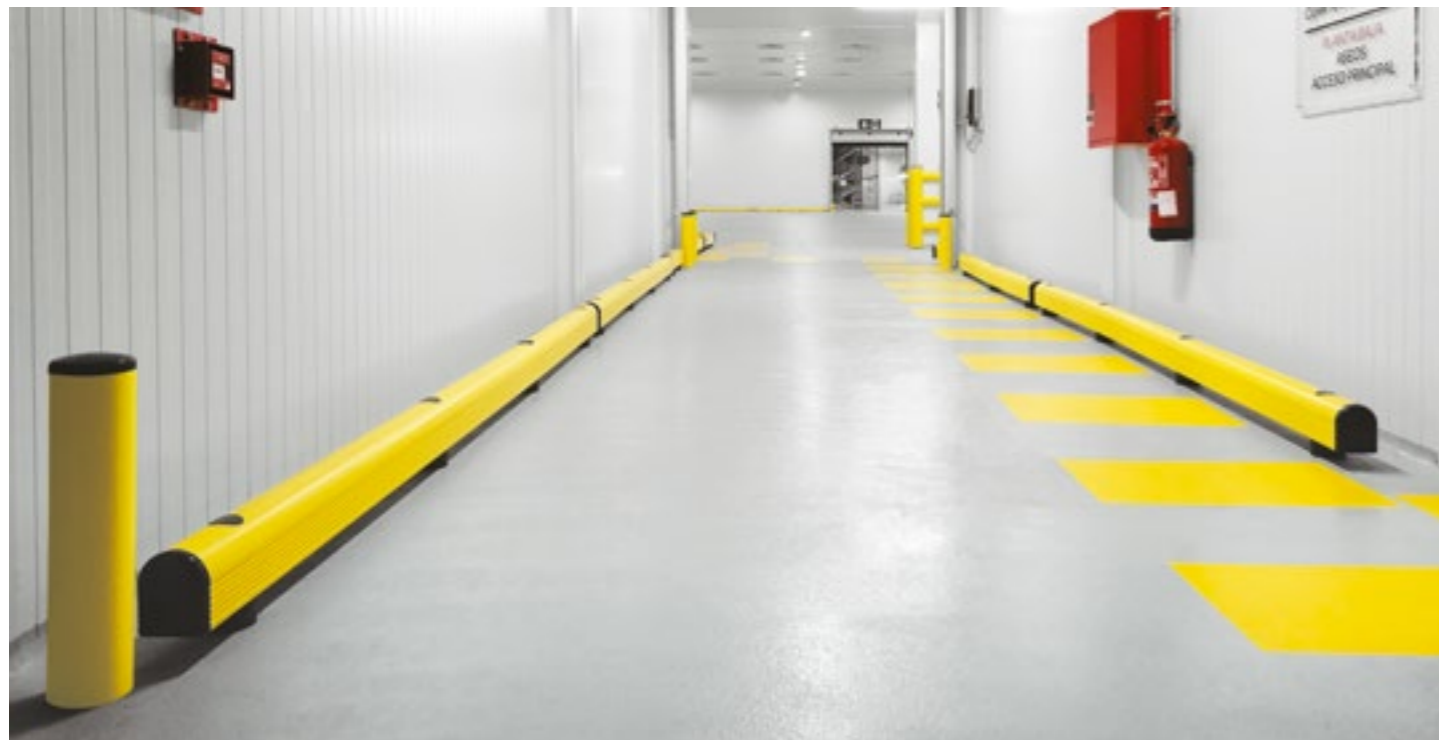

GUARD RAIL 150



HIGH
RESISTANCE
WITH
RESIN



SF20
STAINLESS STEEL

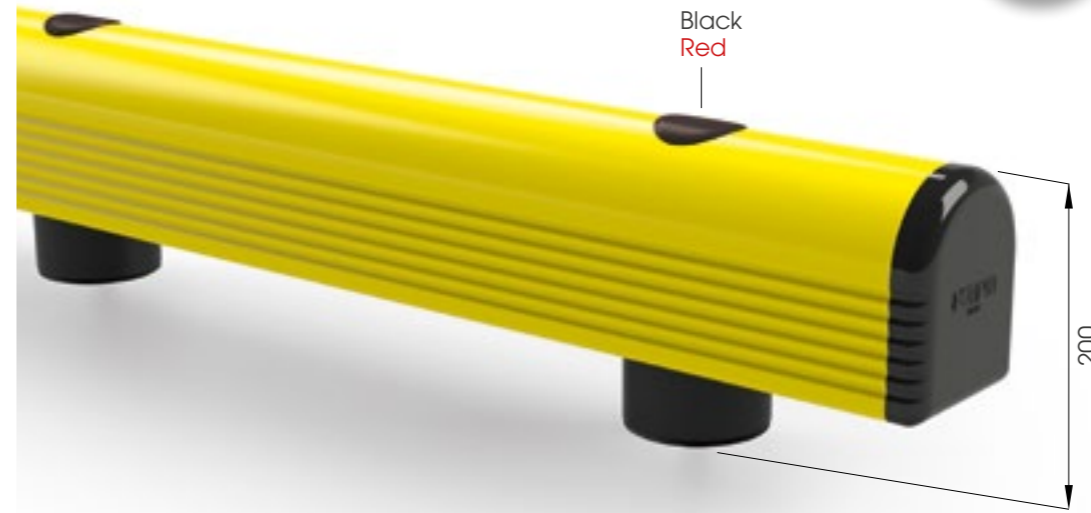

GR 150 500
750
1000
1500

Length 500 / 750 /
1000 / 1500 mm

Packing unpacked on pallet

Colour B M

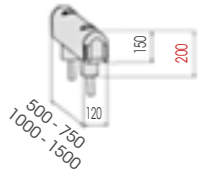

Equipped with accessories

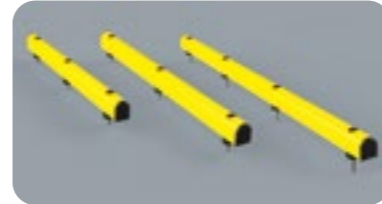

GR 150 2000
3000
4000

Length 2.000 / 3.000 / 4.000 mm

Packing unpacked on pallet

Colour B M

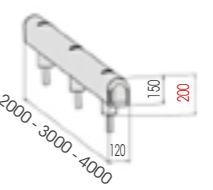

Equipped with accessories



GRIN 90

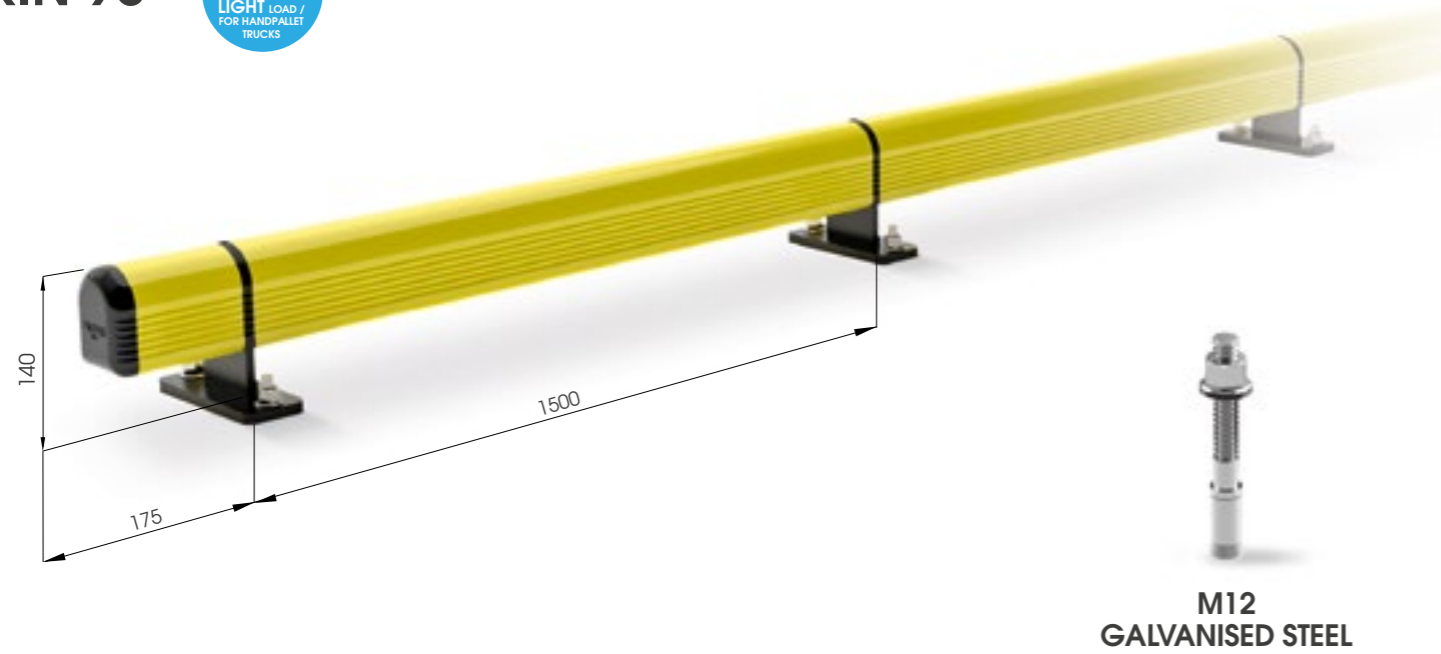

GRIN 150



GRIN 90 1500

Length **1500 mm**
Packing **to be defined**
Colour **M**

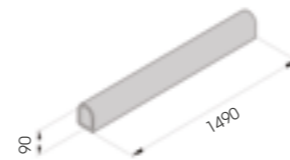

GRINCO 90

Packing **to be defined**
Colour **M**



Equipped with accessories



GRINT 90

Packing **to be defined**
Colour **M**



Equipped with accessories



GRIN 150 2000

Length **2000 mm**
Packing **to be defined**
Colour **M**

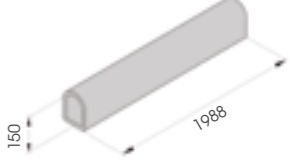

GRINCO 150

Packing **to be defined**
Colour **M**



Equipped with accessories



GRINT 150

Packing **to be defined**
Colour **M**



Equipped with accessories

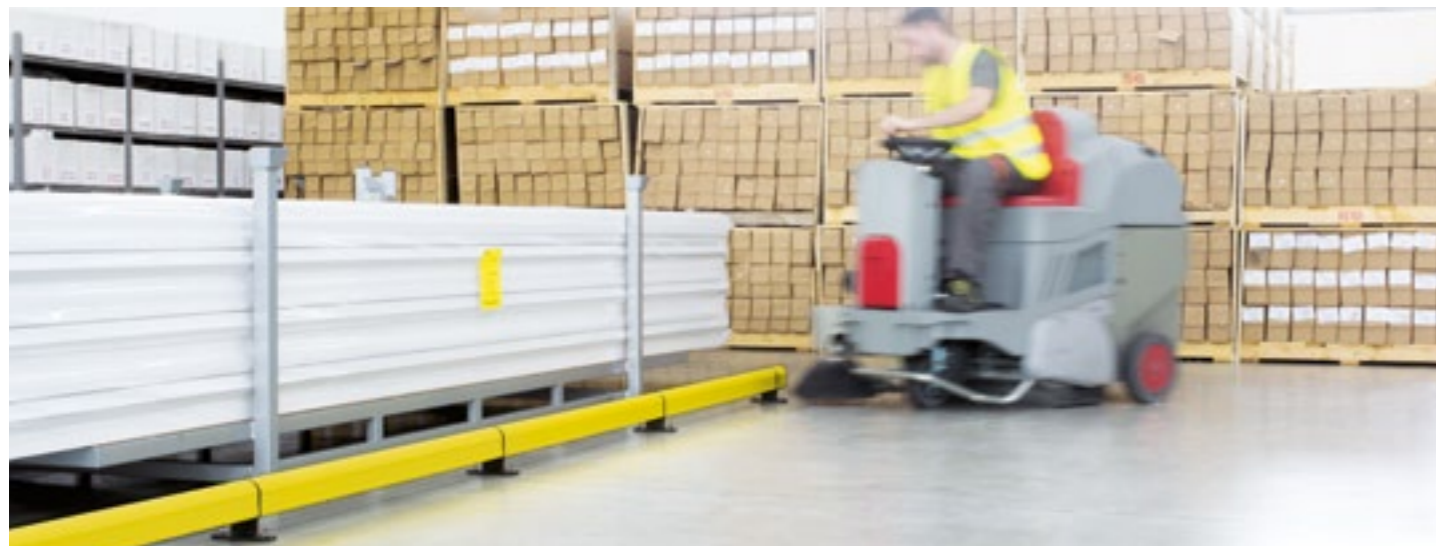

04

COLD LINE

Specific solutions for the protection of areas at risk of impact, in environments with negative temperature. They are suitable to protect corners, entrances, gates, panels and cold rooms walls.

Soluzioni specifiche per la protezione di zone a rischio d'impatto in ambienti a temperatura negativa. Ideali per proteggere angoli sporgenti, accessi e portoni, pannelli e pareti di celle frigorifere.

Solutions spécifiques pour la protection des zones à risque de collision dans les environnements à température négative. Idéal pour protéger les angles, les entrées et les portes, les panneaux et les murs des chambres froides.

Soluciones específicas para proteger las zonas con riesgo de impacto en entornos de temperatura negativa. Son ideales para proteger esquinas, entradas y puertas, paneles y paredes de las cámaras frigoríficas.

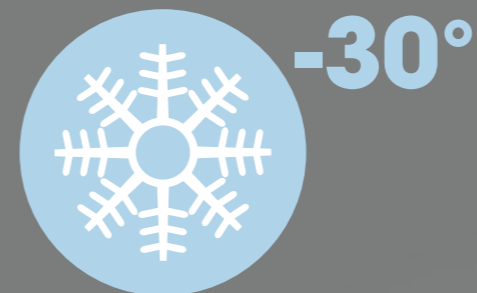

RESISTANT
TO LOW
TEMPERATURES



ROD 70



RE
EASY TO
REMOVE AND
TO REPLACE

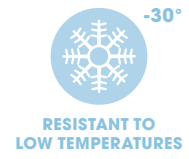

ROD 120



RE
EASY TO
REMOVE AND
TO REPLACE

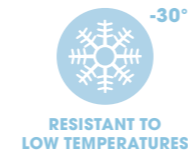

Fixing accessory available also in stainless steel



ROD PE 70 266 RE

Packing Colour **C**
1 pz / box

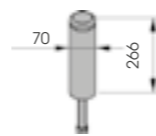

Drill \varnothing 38
Equipped with accessories

Fixing accessory available also in stainless steel



**ROD PE 120 433 RE
560 RE**

Packing Colour **M**
1 pz / bag

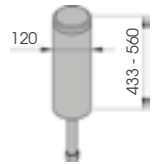

Drill \varnothing 56
Equipped with accessories



ROD FLOOR 70



**QUICK
INSTALLATION
WITH
EXPANSION
SCREW**



**M16
GALVANISED STEEL**

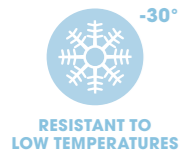

**RESISTANT TO
LOW TEMPERATURES**

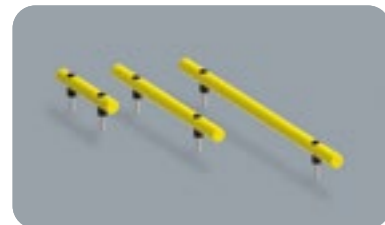

RF 70 500
1000
1500

Length 500 / 1000 / 1500 mm
Packing unpacked on pallet
Colour **M**

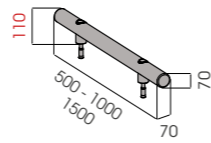

Equipped with accessories

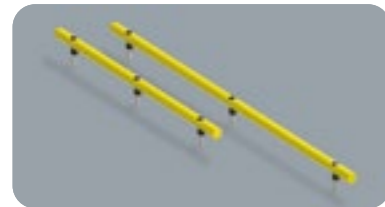

RF 70 2000
3000

Length 2.000 / 3.000 mm
Packing unpacked on pallet
Colour **M**

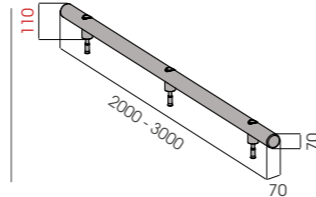

Equipped with accessories

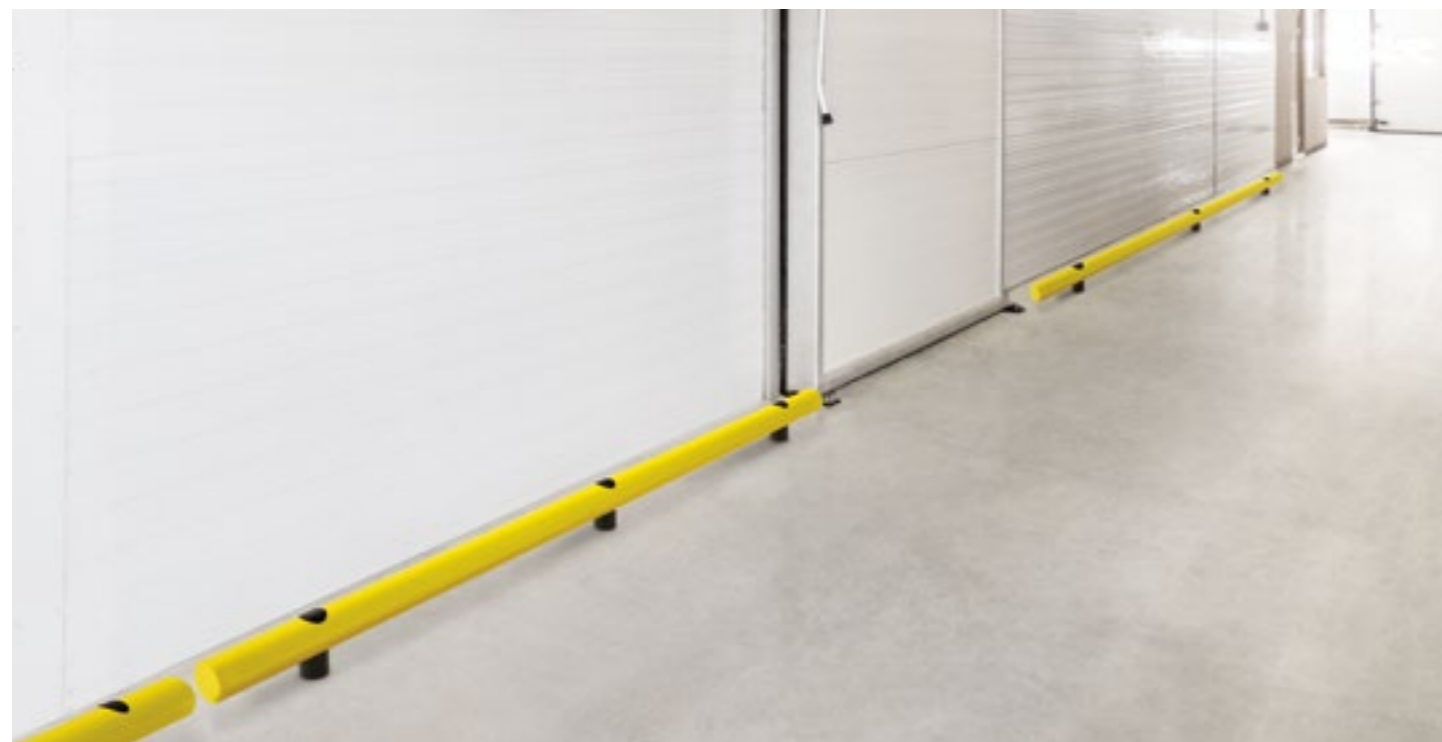

ROD FLOOR 120



**HIGH
RESISTANCE
WITH
RESIN**



**M20
STAINLESS STEEL**

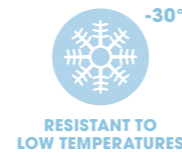
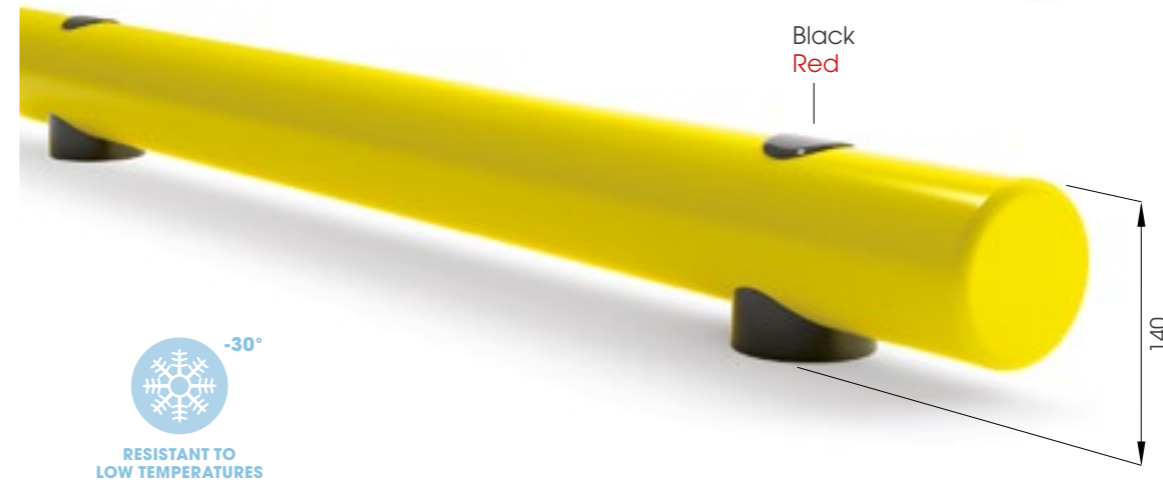

**RESISTANT TO
LOW TEMPERATURES**

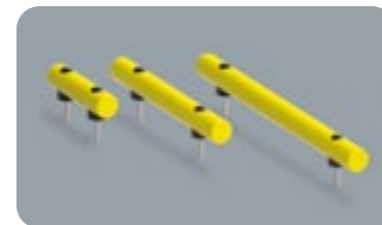

RF 120 500
1000
1500

Length 500 / 1000 / 1500 mm
Packing unpacked on pallet
Colour **M**

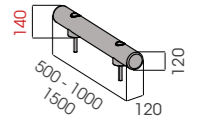

Equipped with accessories

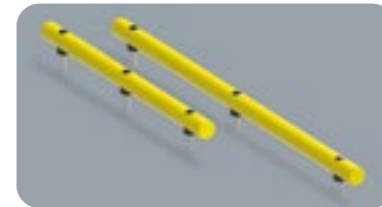

RF 120 2000
3000

Length 2.000 / 3.000 mm
Packing unpacked on pallet
Colour **M**

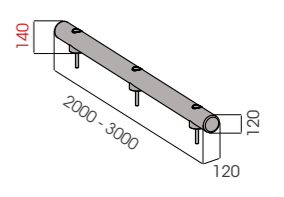

Equipped with accessories



05

PEDESTRIAN SAFETY BARRIERS



A new protection system specific for the protection of pedestrians and resistant to trolleys movements with different load types. Designed by following an innovative technical design that combines speed and simplicity in the steps of installation and cleaning. Available in different lengths.

Sistema di profili antiurto specifico per la protezione delle aree pedonali dai carrelli in movimento con diverse portate di carico. Progettato seguendo un innovativo disegno tecnico che coniuga rapidità e semplicità nelle fasi di installazione e pulizia. Disponibile in diverse lunghezze.

Nouveau système bumper, spécifique pour protéger les zones piétonnes contre les mouvements des charriots. Étudié avec un modern dessin qui regroupe la rapidité et la facilité pendant l'installation et le nettoyage. Disponible en différents longueurs.

Sistema específico de perfiles antichoque para la protección de zonas peatonales de carros en movimiento con diferentes capacidades de carga. Diseñado según un diseño técnico innovador que une velocidad y simplicidad en las fases de instalación y limpieza. Disponible en diferentes longitudes.



HAND RAIL 90

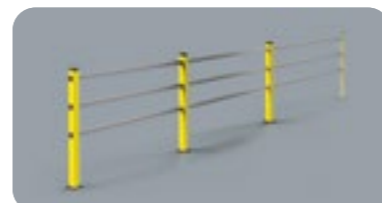

HR 90 1500x1150 MODULAR

Packing Colour **unpacked on pallet** M

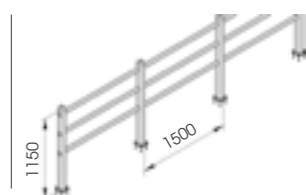

Equipped with accessories

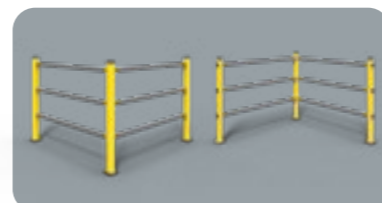

HR 90 1500x1150 CORNER

Packing Colour **unpacked on pallet** M

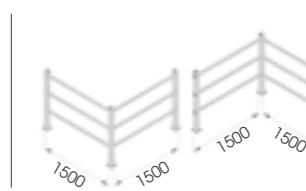

Equipped with accessories



PEDESTRIAN 90



FAST AND EASY TO INSTALL

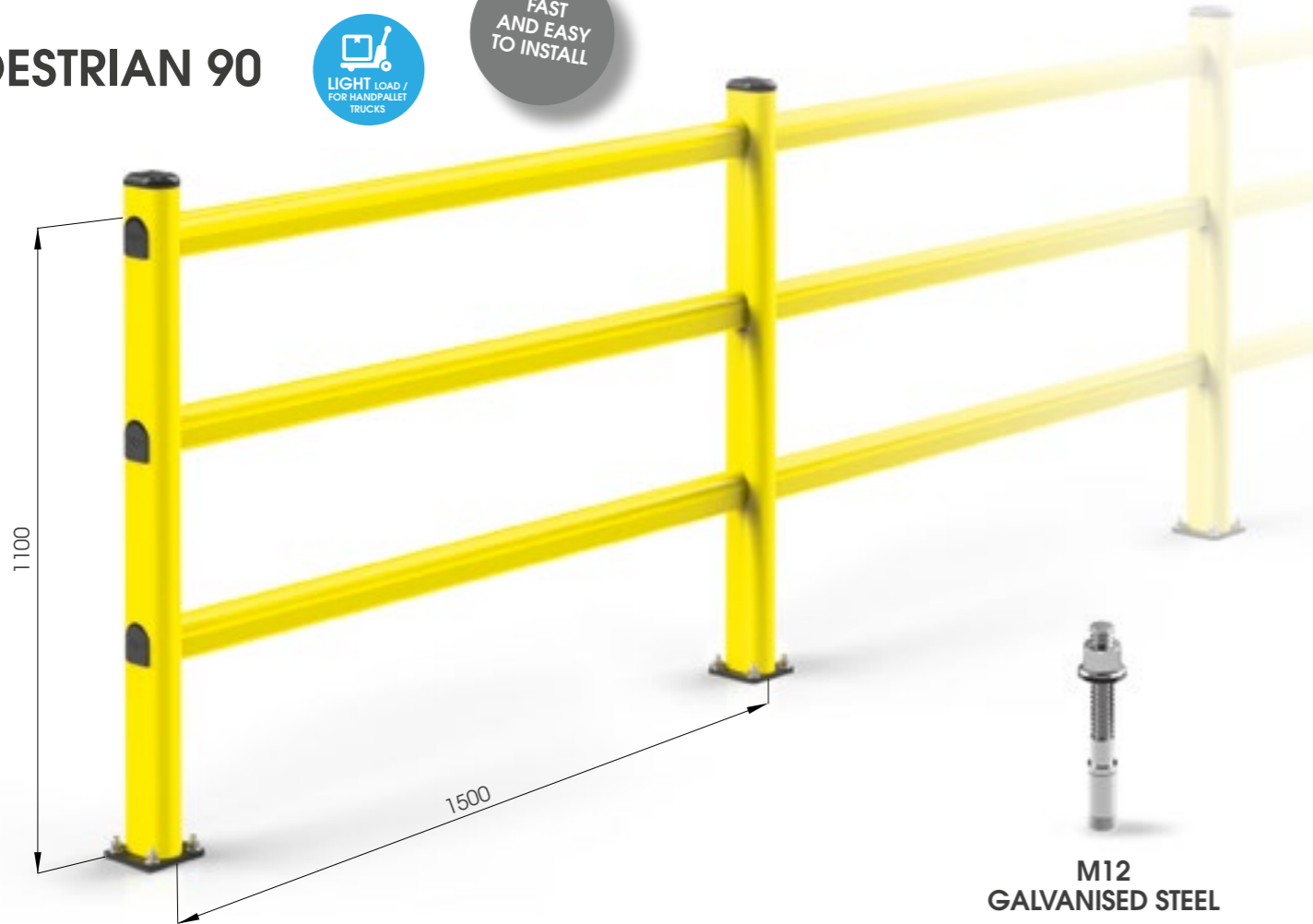

M12 GALVANISED STEEL



PEDESTRIAN 90 1500x1150 MODULAR

Packing Colour **unpacked on pallet** B M



Equipped with accessories

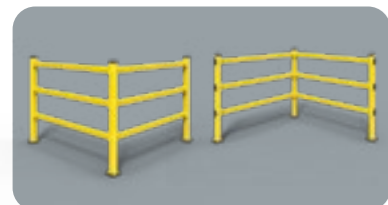

PEDESTRIAN 90 1500x1150 CORNER

Packing Colour **unpacked on pallet** B M

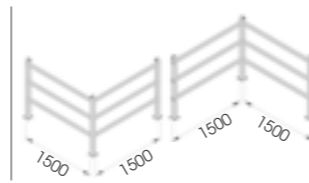

Equipped with accessories



PEDESTRIAN 150



FAST AND EASY TO INSTALL



M12 GALVANISED STEEL



PEDESTRIAN 150 2000x1150 MODULAR

Packing Colour **unpacked on pallet** B M

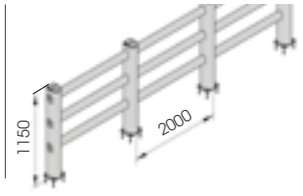

Equipped with accessories



PEDESTRIAN 150 2000x1150 CORNER

Packing Colour **unpacked on pallet** B M



Equipped with accessories



PEDESTRIAN 90 REINFORCED



M12 GALVANISED STEEL



PED 90 REF MODULAR

Packing Colour **unpacked on pallet**
 B M

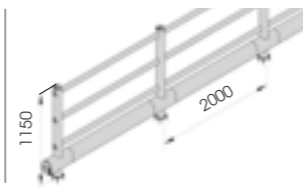

Equipped with accessories



PEDESTRIAN 150 REINFORCED LINK



M12 GALVANISED STEEL



PED 150 REF LINK

Packing Colour **unpacked on pallet**
 B M



Equipped with accessories



06

DOORS

Safety gate system with different opening possibilities, ideated to be installed on our pedestrian barriers. Designed by following an innovative technical design that combines speed and simplicity in the steps of installation and cleaning. Available in different opening systems.

Sistema di cancelli antiurto ideati per l'installazione nelle nostre barriere di protezione per aree pedonali. Progettati seguendo un innovativo disegno tecnico che coniuga rapidità e semplicità nelle fasi di installazione e pulizia. Disponibili molteplici sistemi di apertura.

Système de portillons résistant aux chocs étudié pour l'installation de nos barrières de protections pour les zones piétons. Portillons conçus suivant un design innovant qui combine rapidité et simplicité pendant le montage et le nettoyage. Différents systèmes d'ouvertures disponibles.

Sistema de puertas antigolpe diseñadas para la instalación de nuestras barreras de protección para áreas peatonales. Diseñado según un diseño técnico innovador que une velocidad y simplicidad en las fases de instalación y limpieza. Están disponibles varios sistemas de apertura.



FULL FRAME



Full frame



DOOR PEDESTRIAN 90

DIFFERENT SIZES ON REQUEST



DP 90 ONE WAY

Equipped with accessories

Packing Colour **to be defined** M

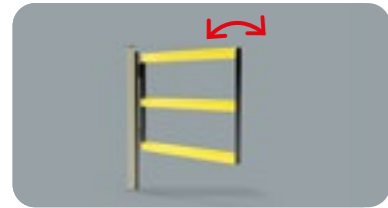
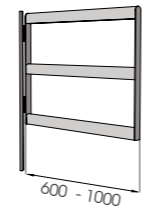

DP 90 SWING

Equipped with accessories

Packing Colour **to be defined** M

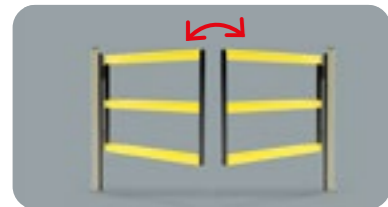
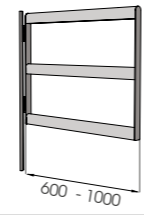

DP 90 SWING DOUBLE

Equipped with accessories

Packing Colour **to be defined** M

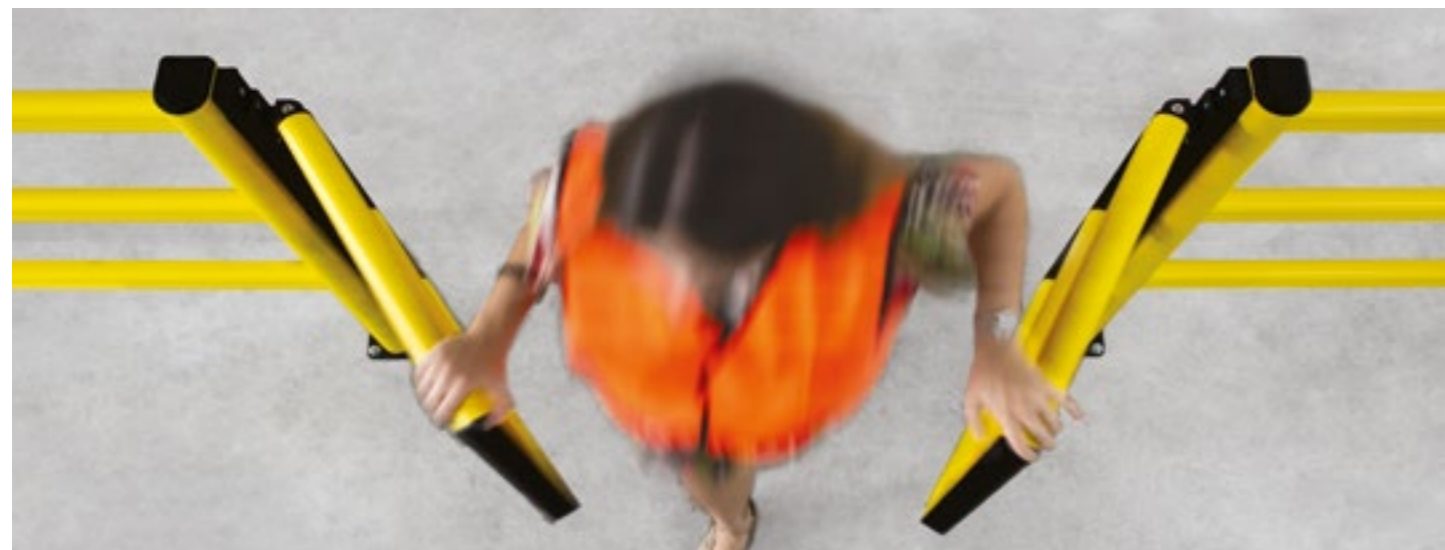
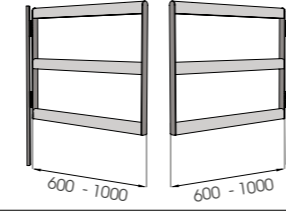

DOOR PEDESTRIAN 150

DIFFERENT SIZES ON REQUEST



DP 150 ONE WAY

Equipped with accessories

Packing Colour **to be defined** M

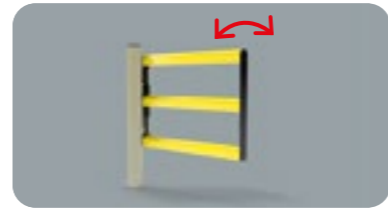
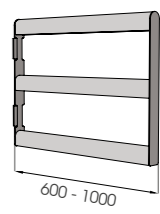

DP 150 SWING

Equipped with accessories

Packing Colour **to be defined** M

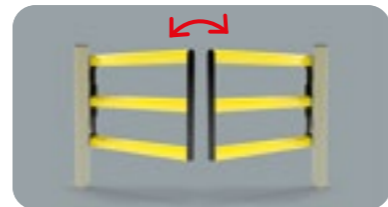
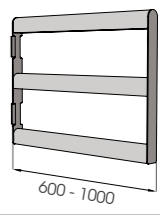

DP 150 SWING DOUBLE

Equipped with accessories

Packing Colour **to be defined** M

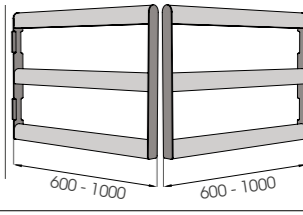

LIFT GATE 90

DIFFERENT SIZES ON REQUEST

NEW

LIFT GATE 90 DOUBLE



DOUBLE GATE

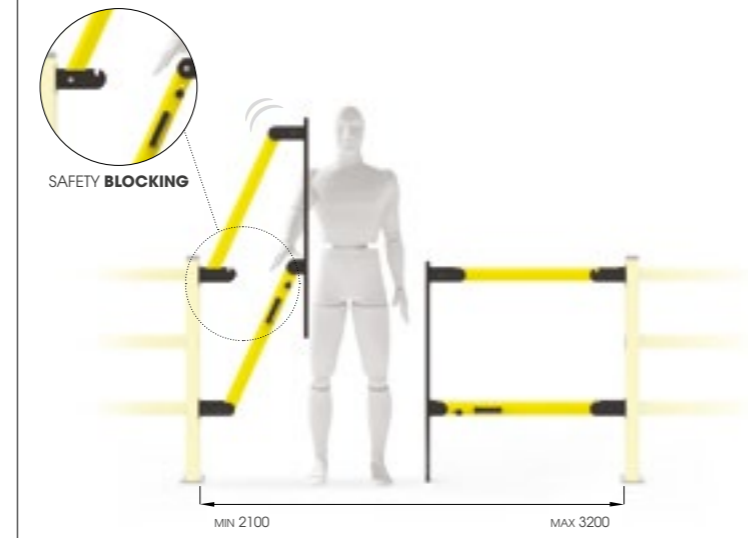
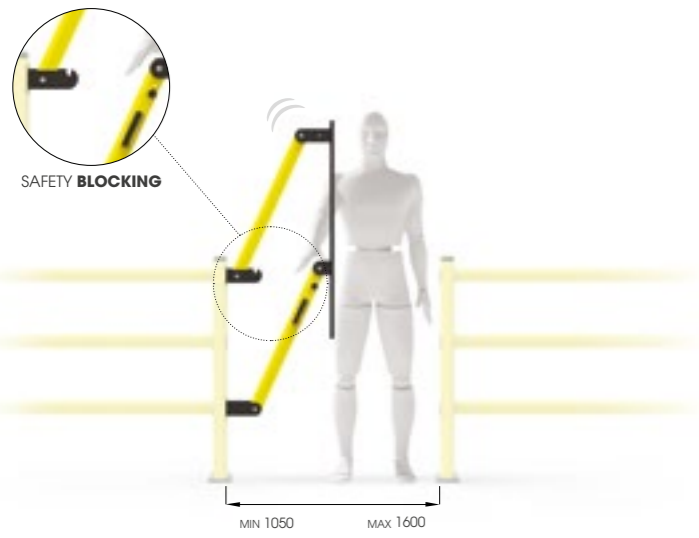

LIFT GATE 90

Equipped with accessories

Packing Colour **to be defined**

M



1050 - 1600

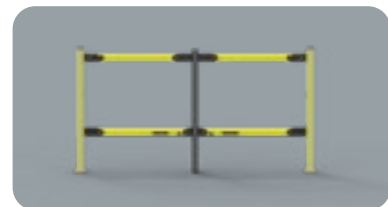

LIFT GATE 90 DOUBLE

Equipped with accessories

Packing Colour **to be defined**

M

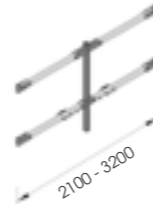

2100 - 3200



LIFT GATE 150

DIFFERENT SIZES ON REQUEST

NEW

LIFT GATE 150 DOUBLE

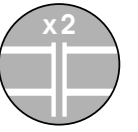

DOUBLE GATE

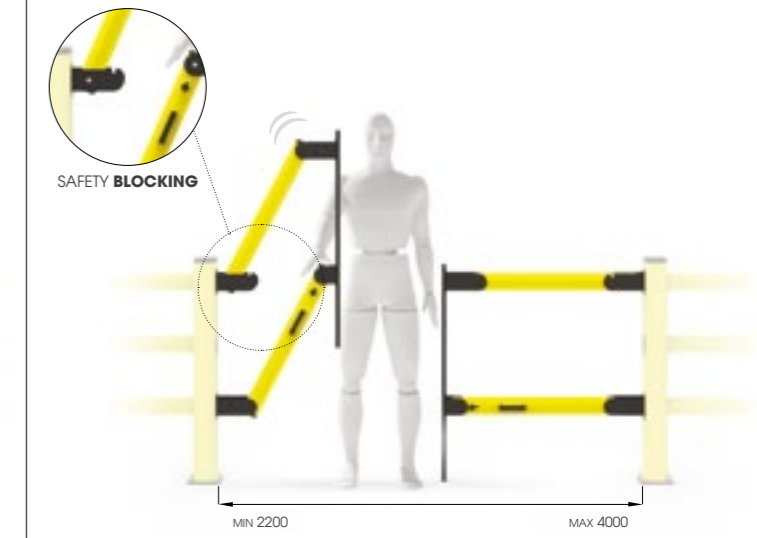
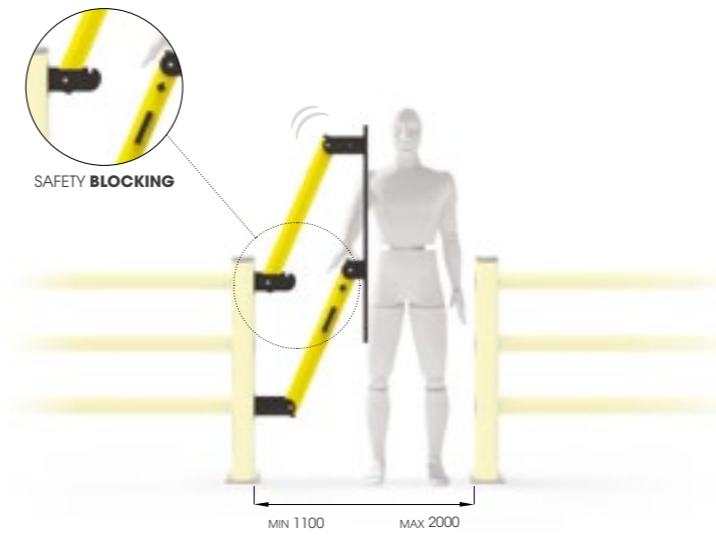

LIFT GATE 150

Equipped with accessories

Packing Colour **to be defined**

M



1100 - 2000

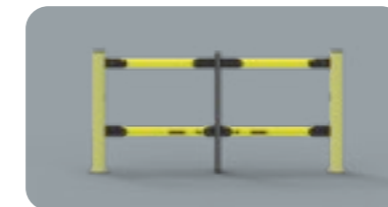

LIFT GATE 150 DOUBLE

Equipped with accessories

Packing Colour **to be defined**

M

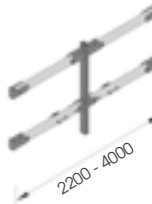

2200 - 4000



07

LINK

The first adaptable barrier in the world thanks to the new connection system. Rail adjustable height, easy to set up, higher resistance in the most critical points.

Prima barriera al mondo regolabile a piacimento con nuovo sistema di raccordo. Altezza regolabile, facilmente componibili e resistenza potenziata nei punti piu' critici.

Première barrière au monde à modifier aux besoins avec un nouveau système de jonction. Hauteur à changer, facile à assembler et résistance renforcée aux points plus compliqués.

Primera barrera del mundo ajustable según lo necesario con un nuevo sistema de ajuste. Altura ajustable, fácilmente componibles y resistencia potenciada en los puntos más críticos.

**NEW
PRODUCT**



**ADAPTABLE
HEIGHT**
↕
**ON YOUR
NEEDS**

LINK 150/3



Link
**DIFFERENT
SIZES ON
REQUEST**

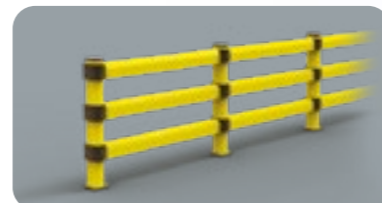

LINK 150/3

Packing Colour **unpacked on pallet**
M

Equipped with accessories

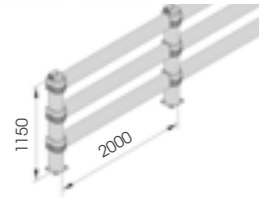

**LINK 150/3
CORNER**

Packing Colour **unpacked on pallet**
M

Equipped with accessories

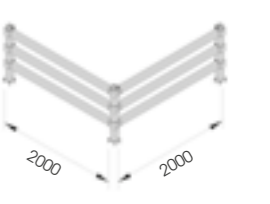

LINK 150/2



DIFFERENT SIZES ON REQUEST

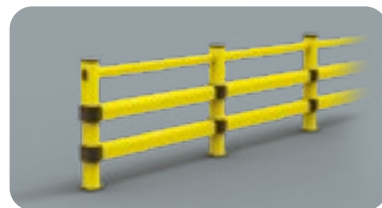
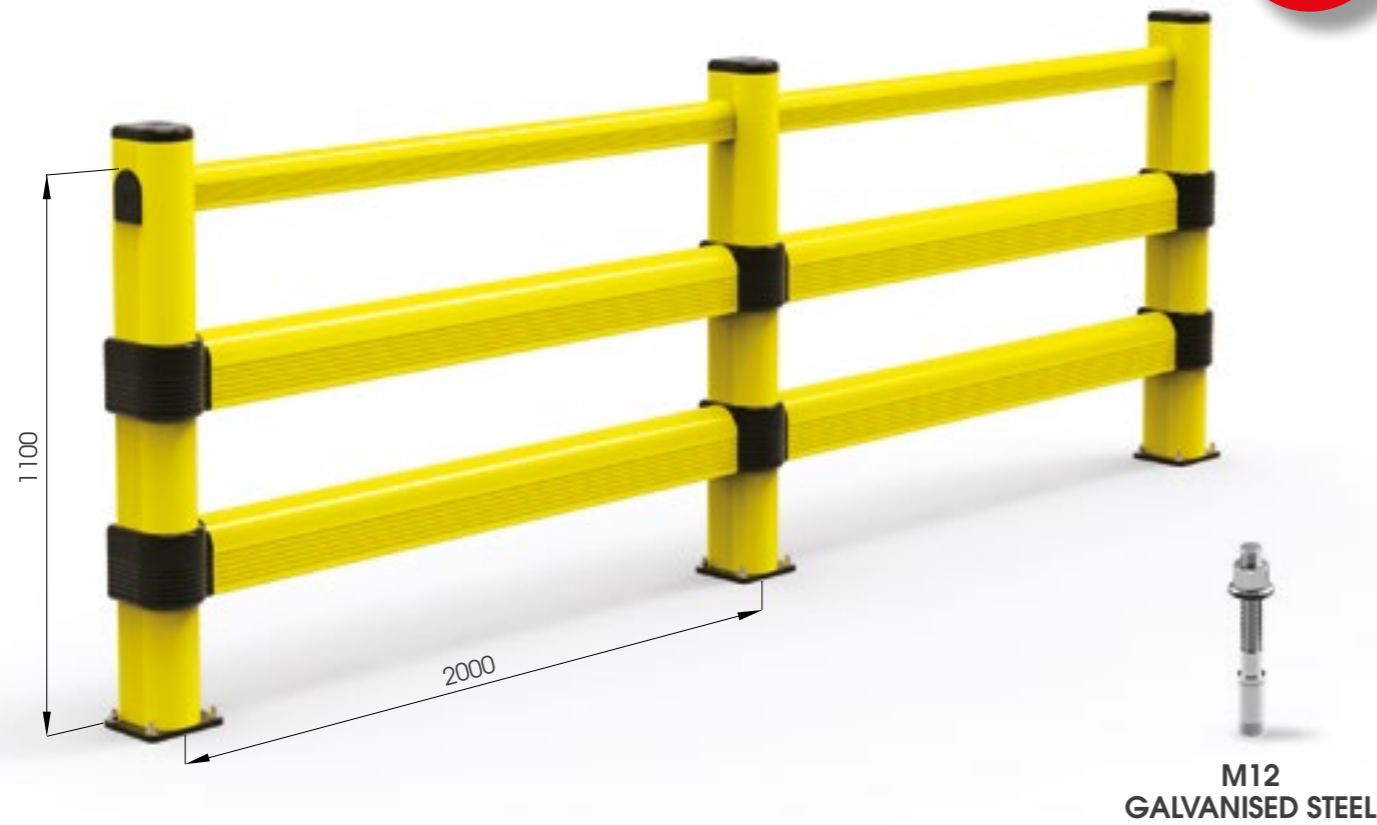

LINK 150/2

Equipped with accessories

Packing Colour **M** unpacked on pallet



LINK 150/1



DIFFERENT SIZES ON REQUEST



LINK 150/1

Equipped with accessories

Packing Colour **M** unpacked on pallet

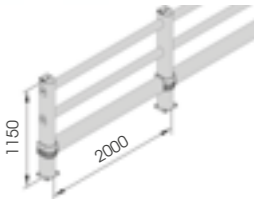

LINK LM



DIFFERENT SIZES ON REQUEST

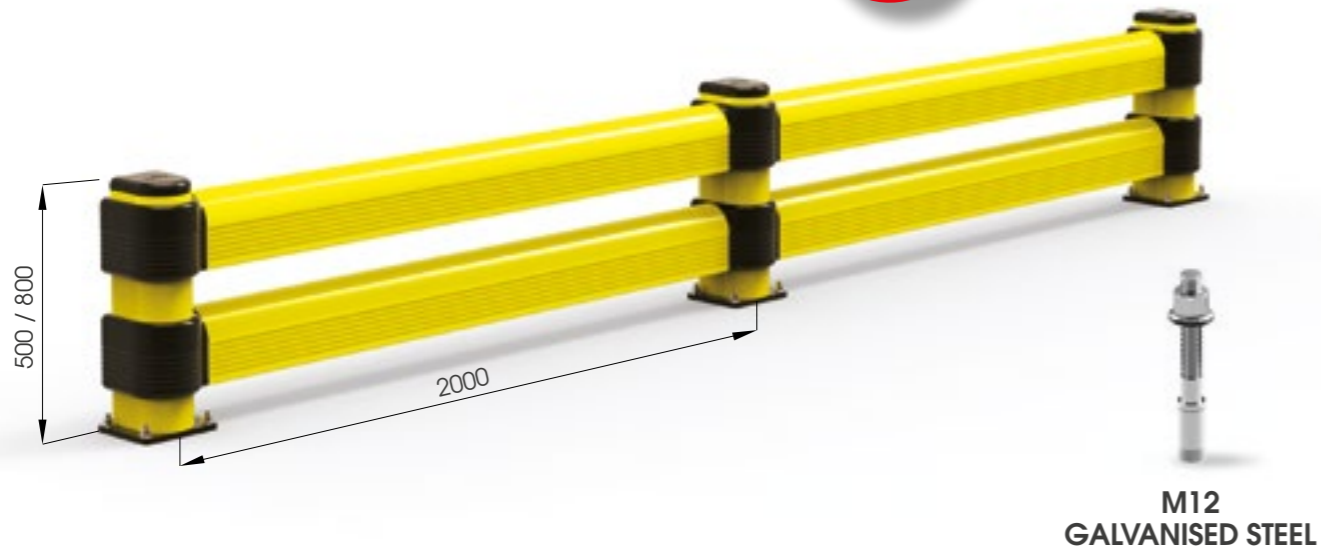

M12 GALVANISED STEEL

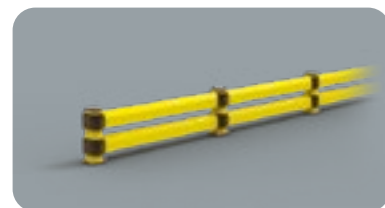

LINK LM 500 800

Equipped with accessories

Packing Colour **M** unpacked on pallet

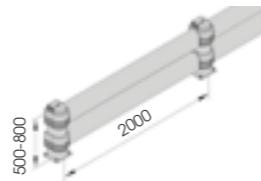

LINK LM CORNER

Equipped with accessories

Packing Colour **M** unpacked on pallet

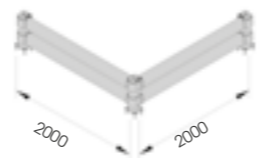

LINK SINGLE



DIFFERENT SIZES ON REQUEST

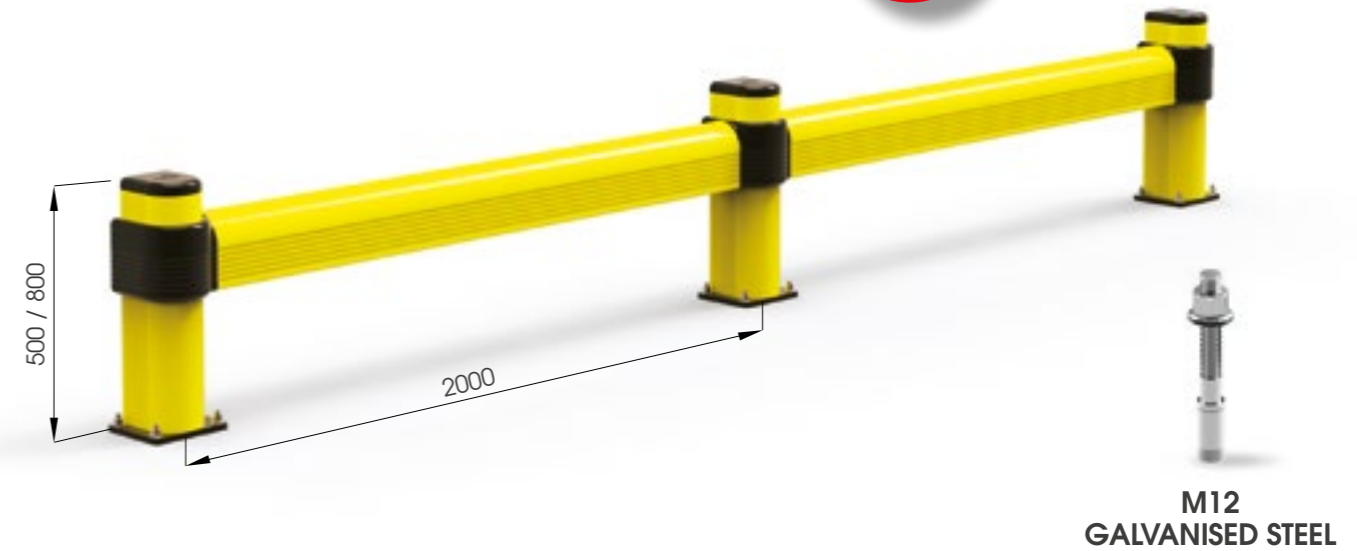

M12 GALVANISED STEEL



LINK SINGLE 500 800

Equipped with accessories

Packing Colour **M** unpacked on pallet

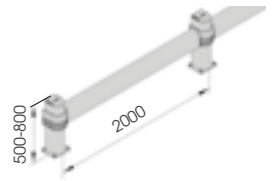

LINK SINGLE CORNER

Equipped with accessories

Packing Colour **M** unpacked on pallet

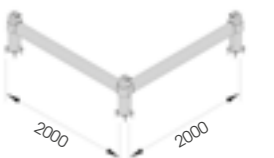

08 BFLEX

A new safety protection system with reinforced profile. It is a more flexible and shock-absorber solution. Designed to ensure high safety standards and to resist impacts from heavy loads. Available in many different versions.

Nuovo sistema di protezioni con profilo rinforzato, doppiamente flessibile e assorbente. Progettato e realizzato con un particolare design per garantire alti livelli di sicurezza e resistere all'impatto da carichi pesanti. Disponibile in diverse versioni.

Nouveau système de protection avec profil renforcé, doublement flexible et absorbant. Conçu et produit avec un design particulier pour assurer des niveaux élevés de sécurité et résister à l'impact des charges lourdes. Disponible en plusieurs versions.

Nuevo sistema de protección con perfil reforzado, más flexible y capaz de absorber los impactos. Diseñado para asegurar el entorno laboral y para resistir a los impactos de cargas pesadas. Disponible en diferentes versiones.

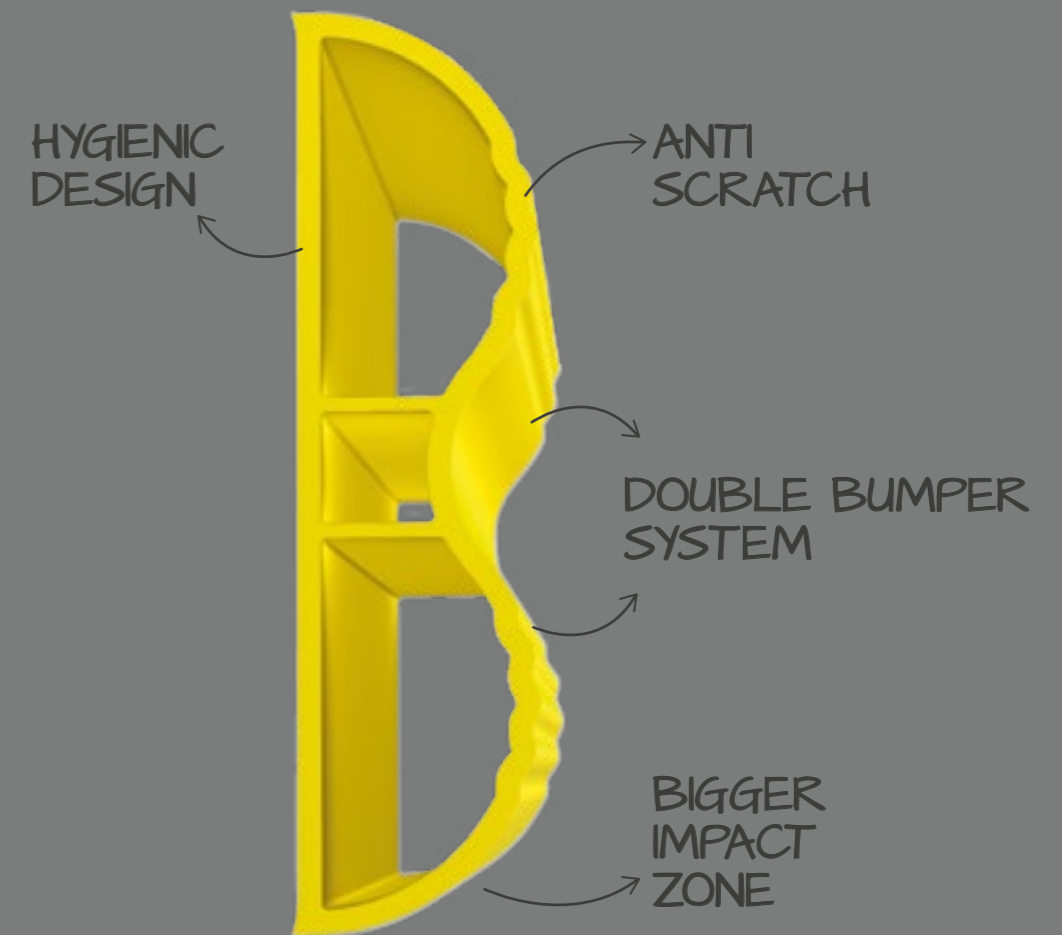

BFLEX.FRONT/1



BFLEX.FRONT/1 2000x450 MODULAR

Equipped with accessories

Packing Colour **M** unpacked on pallet

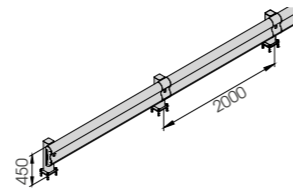

BFLEX.FRONT/1 1100x450
BFLEX.FRONT/1 2400x450

Equipped with accessories

Length Packing Colour **M** 1.100 / 2.400 mm unpacked on pallet

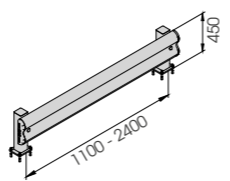

BFLEX.FRONT/2



BFLEX.FRONT/2 2000x1100 MODULAR

Equipped with accessories

Packing Colour **M** unpacked on pallet

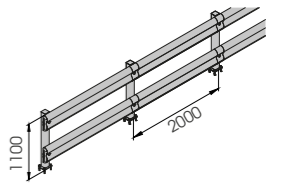

BFLEX.FRONT/2 1100x1100
BFLEX.FRONT/2 2400x1100

Equipped with accessories

Length Packing Colour **M** 1.100 / 2.400 mm unpacked on pallet

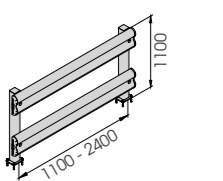

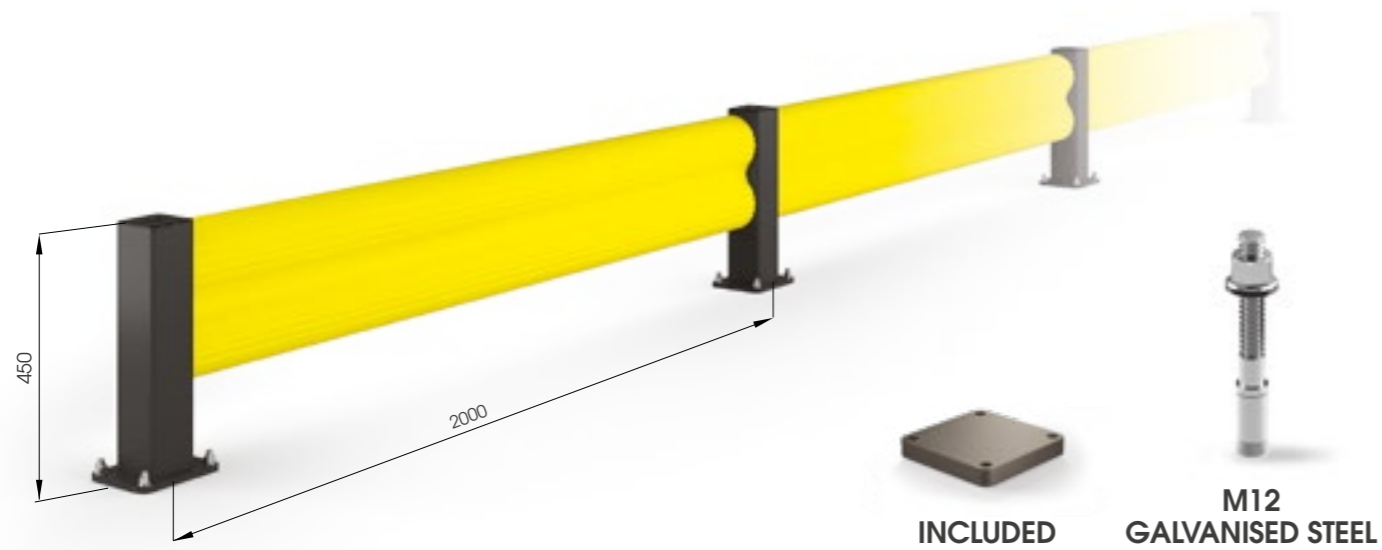

BFLEX.COM/1 2000x450 MODULAR

Equipped with accessories

Packing Colour **B** **M** unpacked on pallet

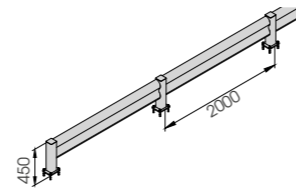

BFLEX.COM/1 1100x450
BFLEX.COM/1 2400x450

Equipped with accessories

Length Packing Colour **B** **M** 1.100 / 2.400 mm unpacked on pallet

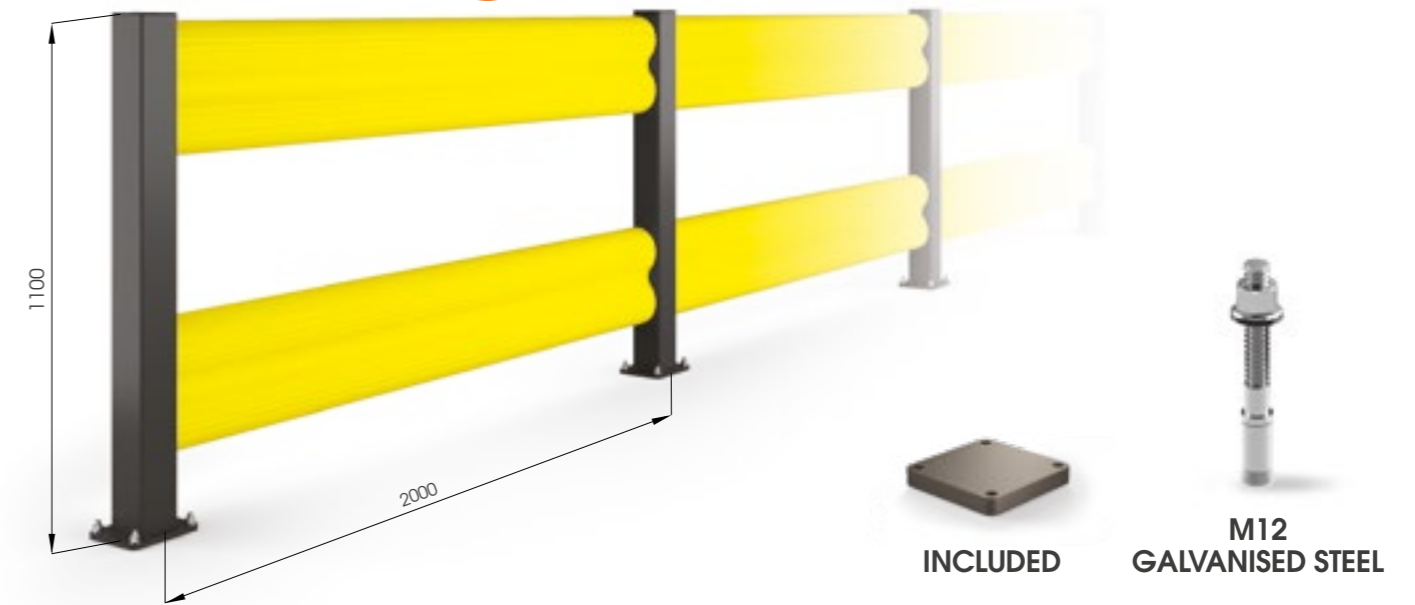
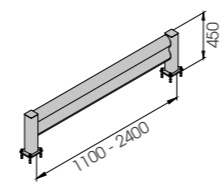

BFLEX.COM/2 2000x1100 MODULAR

Equipped with accessories

Packing Colour **B** **M** unpacked on pallet

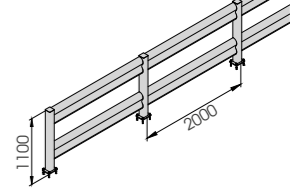

BFLEX.COM/2 1100x1100
BFLEX.COM/2 2400x1100

Equipped with accessories

Length Packing Colour **B** **M** 1.100 / 2.400 mm unpacked on pallet

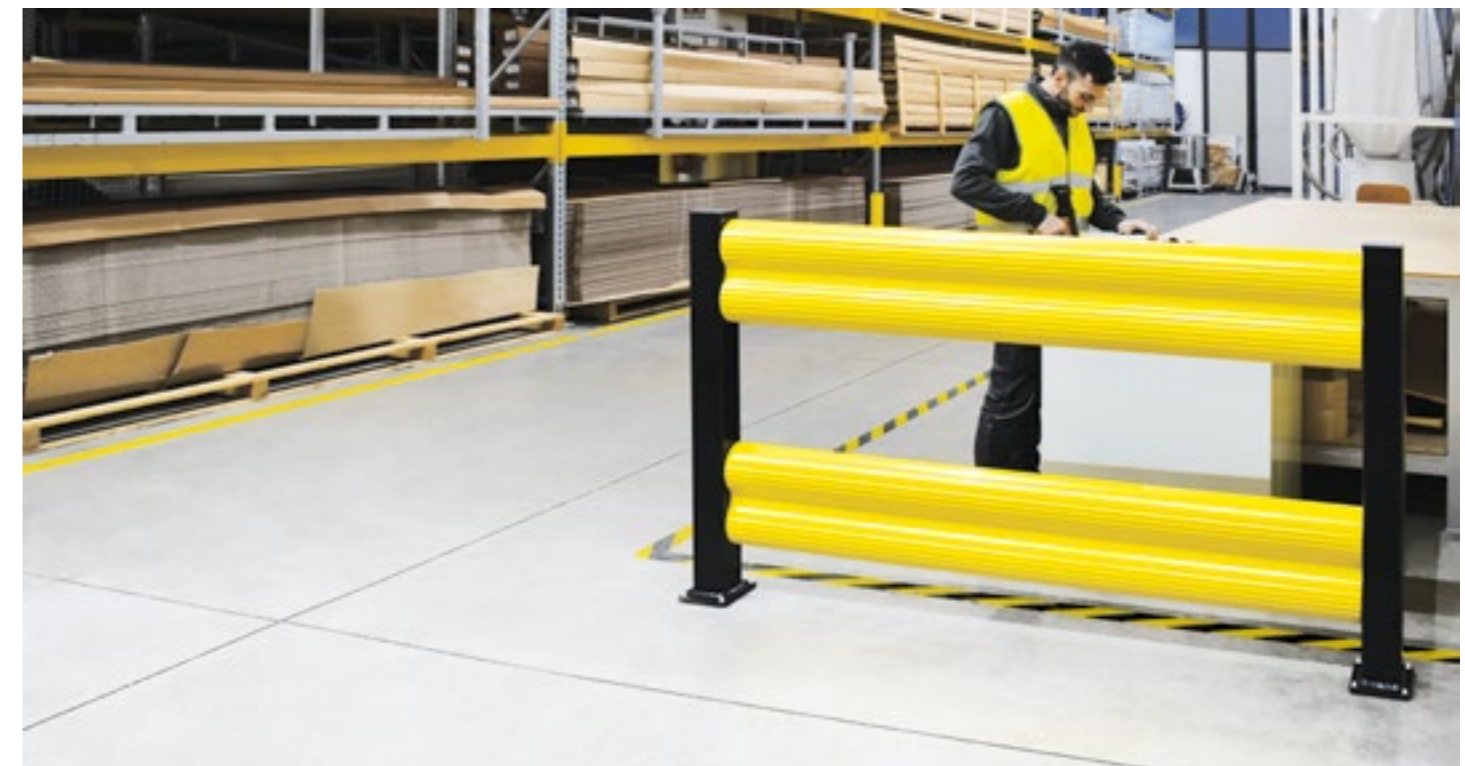
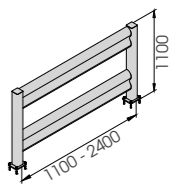

NOW READY
NEW OPTIONS FOR
OUR **SAFETY BARRIERS**
AND **RACK PROTECTORS**



AVAILABLE FOR:
LINK / SM / LM / FENCE
HR 90 / PED 90 / PED 150



09

COLUMN PROTECTION

A new bumper system specific for the protection of the columns resistant against trolleys movements and for different load types. Designed by following an innovative technical design that combines speed and simplicity in the steps of installation and cleaning. Available in different heights and fixing systems.



Sistema di profili specifico per la protezione delle colonne dai carrelli in movimento di varie portate. Progettato seguendo un innovativo disegno tecnico che coniuga rapidità e semplicità nella fasi di installazione e pulizia. Disponibile in diverse altezze e tipologie di fissaggio.

Nouveau système bumper, spécifique pour protéger les poteaux contre les mouvements des chariots. Étudié avec un modern dessin qui regroupe la rapidité et la facilité pendant l'installation et le nettoyage. Disponible en différents hauteurs et différents fixations.

Sistema de perfiles específico para la protección de las columnas de los carros en movimiento de diferentes capacidades. Diseñado según un innovador diseño técnico que une velocidad y simplicidad en las fases de instalación y limpieza. Disponible en diferentes alturas y tipos de fijación.



- REMOVABLE
- NO SCRATCHES
- VERY SOLID AND SLIM DESIGN
- NO FIXING IS REQUIRED

COLUMN PROTECTION 90



DIFFERENT SIZES ON REQUEST

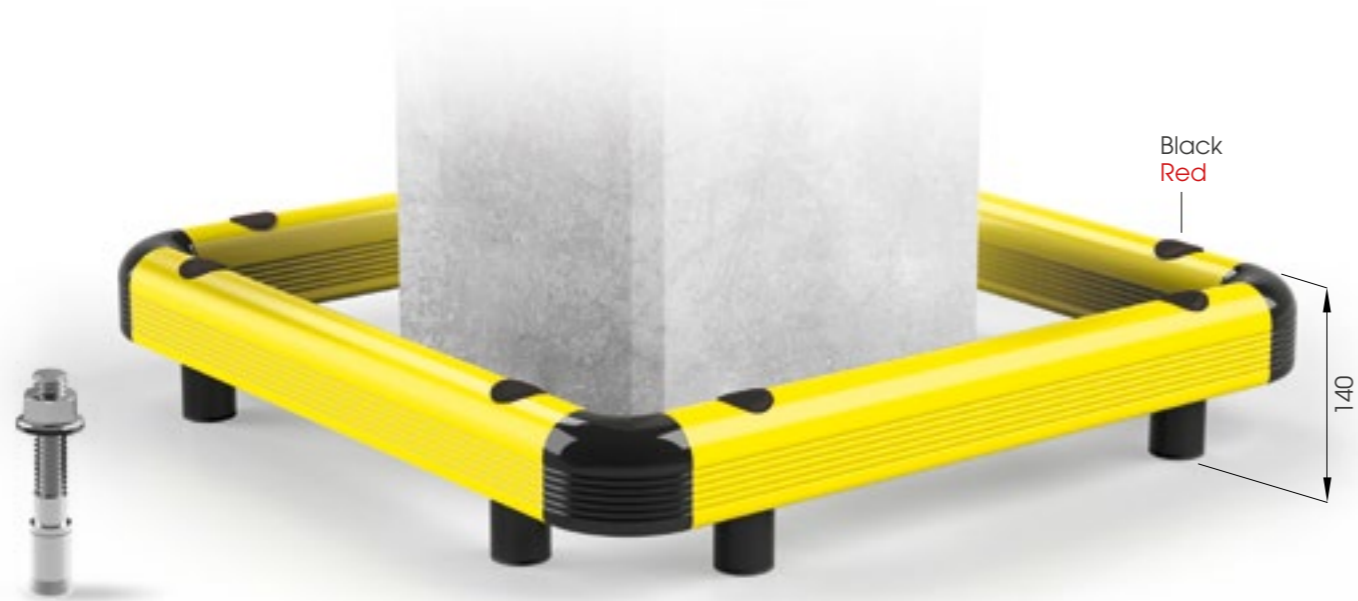

M16
STAINLESS STEEL



COPRO 90 500x500
600x600
700x700

Packing Colour **M** unpacked on pallet

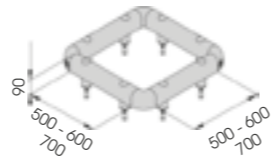

Equipped with accessories



COLUMN PROTECTION 150



DIFFERENT SIZES ON REQUEST

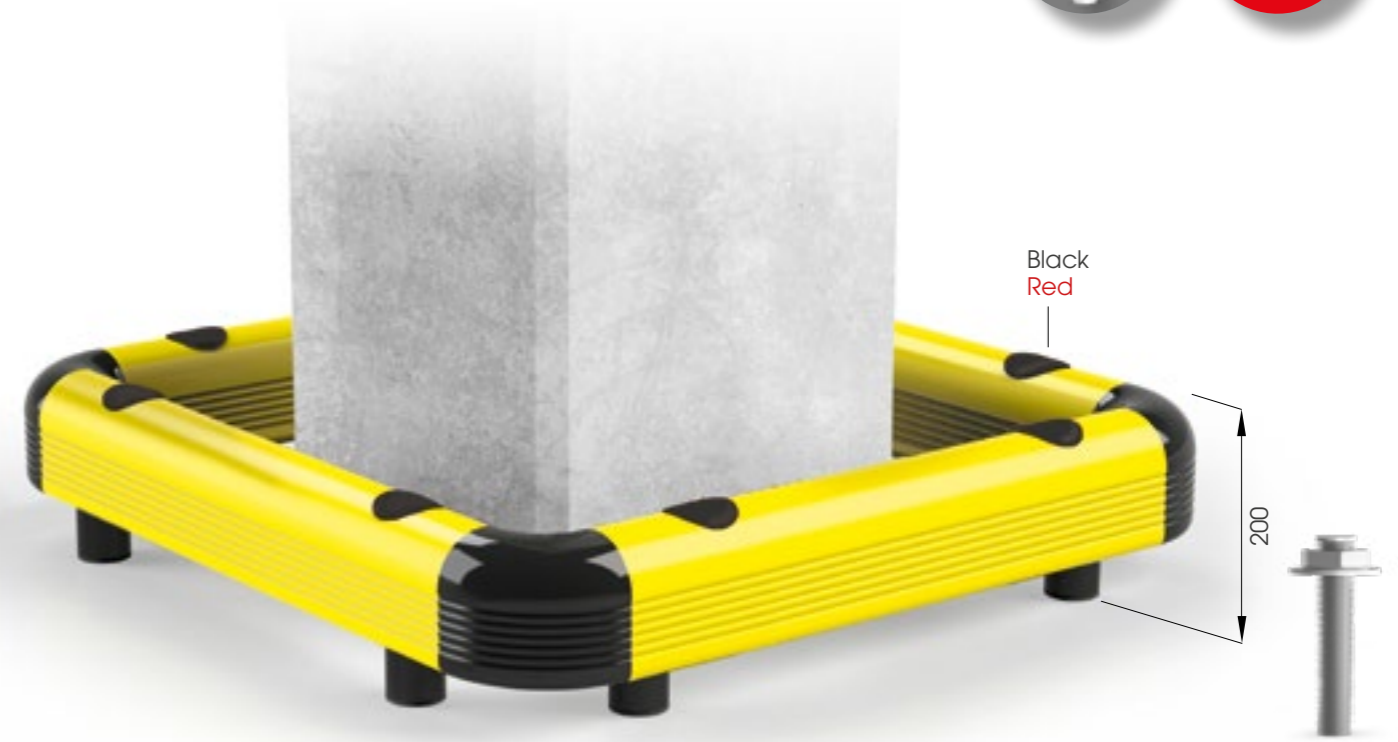

M20
STAINLESS STEEL



COPRO 150 500x500
600x600
700x700

Packing Colour **M** unpacked on pallet

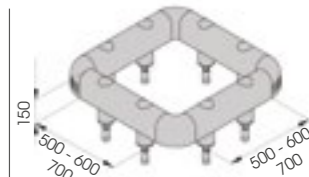

Equipped with accessories



HUG TOWER



CHOOSE THE HEIGHT YOU NEED!
UP TO 5 RAILS

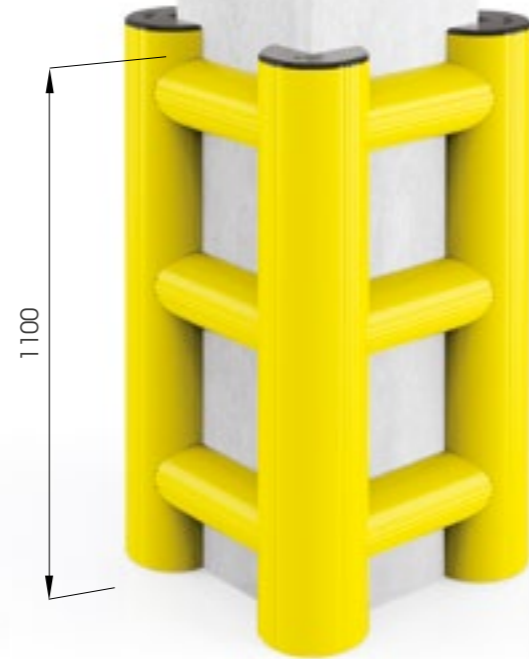
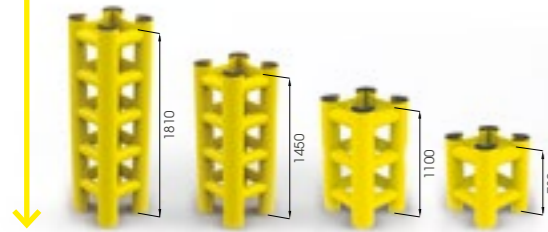

DIFFERENT SIZED AND HEIGHT ON REQUEST

COMPACT



NO HOLES ON THE FLOOR AND COLUMN!



HUG TOWER 500x500
600x600
700x700

Packing Colour **M**

Equipped with accessories

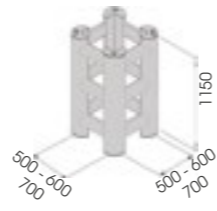

HUG TOWER 3 SIDES

Packing Colour **M**

Equipped with accessories

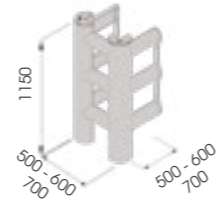

TOWER PROTECTION



DIFFERENT SIZES ON REQUEST



M12 GALVANISED STEEL



TOWER 500x500
600x600
700x700

Packing Colour **M**

Equipped with accessories

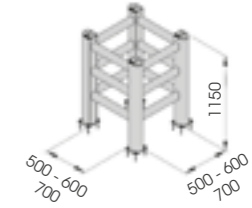

10

LOADING BAYS PROTECTIONS

Loading bays protections are shock-proof solutions which are set up near loading doors. They avoid possible slipping, falling and flipping of moving vehicles near open and unmanned loading bays.

Sistema di protezione antiurto installato in prossimità delle porte di carico. Permettono di evitare situazioni ad alto rischio di scivolamento, caduta e ribaltamento dei mezzi in movimento in presenza di baie di carico aperte e non presidiate.

Système de protection contre les chocs installé près des portes de chargement. Ils permettent d'éviter des situations en raison du risque élevé de glissement, de chute et de basculement des véhicules en mouvement en présence de quais de chargement ouverts et sans surveillance.

La protección de muelles de carga es un sistema anticolidión que está cerca de las puertas de carga. Evitan los riesgos de deslizamiento, caída y derrocamiento los vehículos en movimiento cuando están cerca de los muelles de carga abiertos y no vigilados.



DOCK GATE



DOCK GATE L 2400-2500

Packing Colour **to be defined**
M

Equipped with accessories

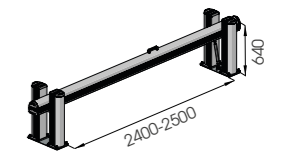

DOCK GATE XL 2500-3000

Packing Colour **to be defined**
M

Equipped with accessories

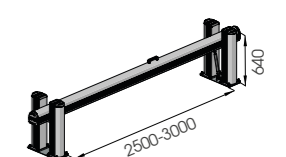

CORNER PROTECTION

Designed to protect pillars and columns or external corners of walls and panels.

Realizzato per proteggere pilastri e colonne o angoli esterni di muri e pannelli.

Étudié pour protéger les poteaux et les colonnes ou les angles extérieurs de murs et de panneaux.

Realizado para proteger pilares y columnas o esquinas exteriores de paredes y paneles.

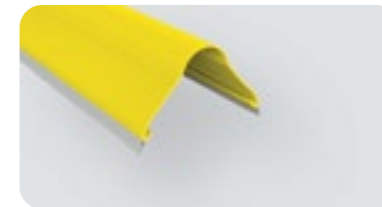

CP 100

Length 4.000 mm
Packing 10 pz / box
Colour B M E F

Length 2.000 mm
Packing 20 pz / bag
Colour M

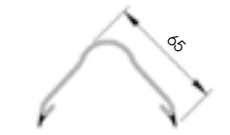

CPF 100

Length 4.000 mm
Packing 10 pz / bag

Length 2.000 mm
Packing 20 pz / bag



CPT 100

Packing 40 pz / box
Colour B E F

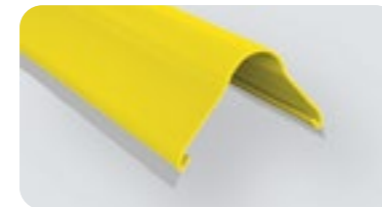
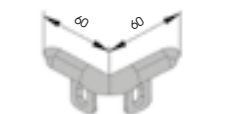

CP 200

Length 4.000 mm
Packing 2 pz / bag
Colour B M E

Length 2.000 mm
Packing 2 pz / bag
Colour M



CPF 200

Length 2.000 / 4.000 mm
Packing 2 pz / bag



CPT 200

Packing 20 pz box
Colour B E

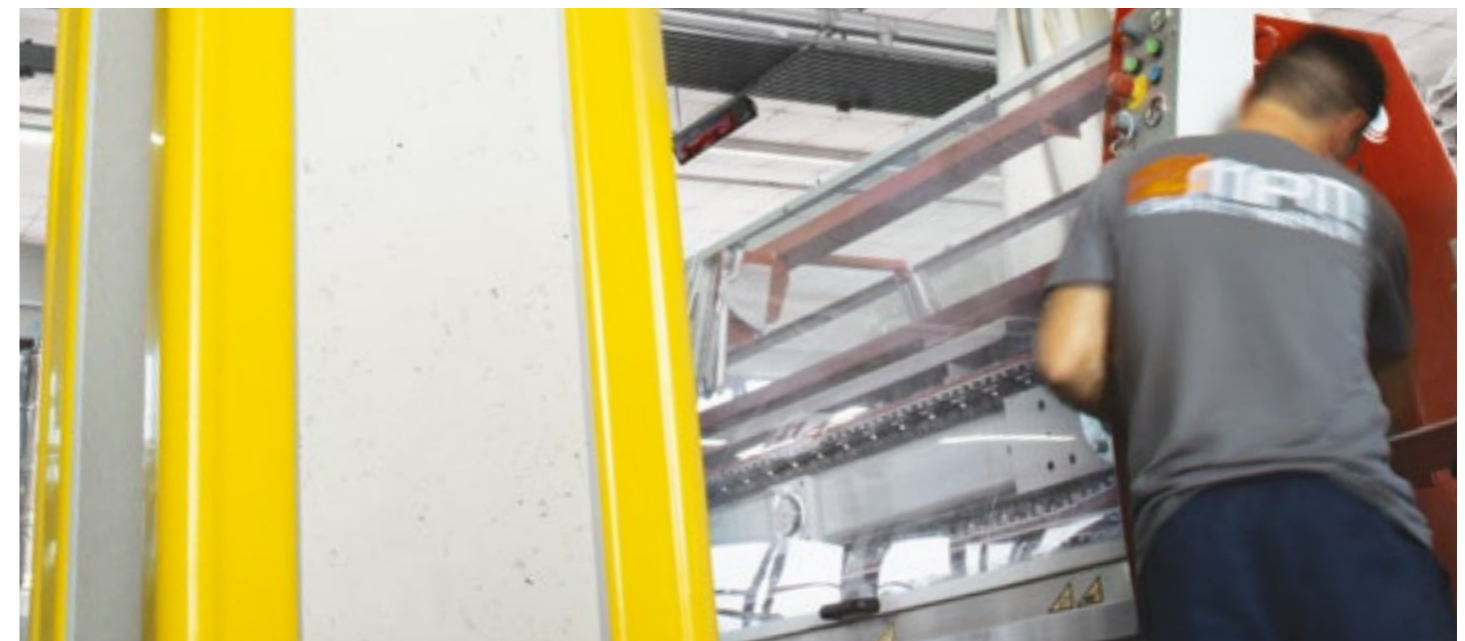
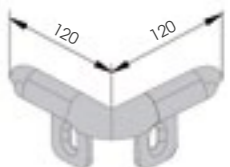

12 KERB

A large size protection system, ideal for walls and panels. Easy to install and clean. Fully equipped with corner caps and buttons.

Sistema di protezione di grandi dimensioni, ideale per muri e pannelli. Facile da installare e pulire. Completo di angolari e tappi.

Système de protection de grands dimensions, idéal pour les murs et les panneaux. Facile à installer et à nettoyer. Complété de bouchons d'angles et d'embouts.

Sistema de protección de grande dimensión, ideal para paredes y paneles. Fácil de instalar y limpiar. Completo de esquinas y tapas.

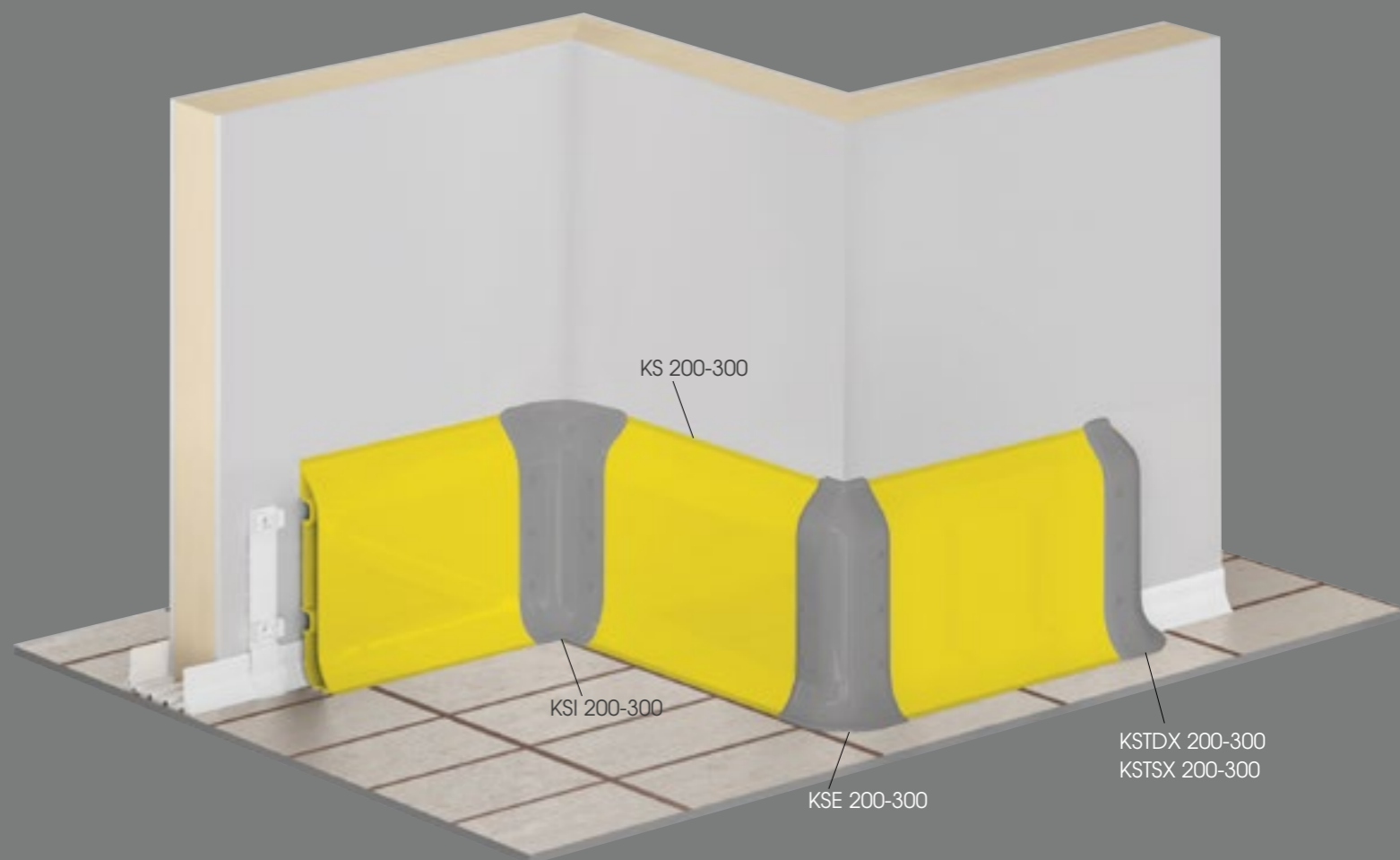



KS 200

Length **4.000 mm**
 Packing **3 pz / box**
 Colour **B M E**

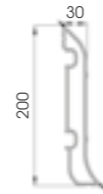

KEPF 200

To install with TB14

Packing **50 pz / box**
 Colour **K**

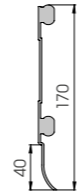

KSJ 200

To install with TB14 / TF14

Packing **20 pz / box**
 Colour **B E**

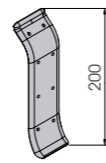

KSI 200

To install with TB14 / TF14

Packing **20 pz / box**
 Colour **B E**

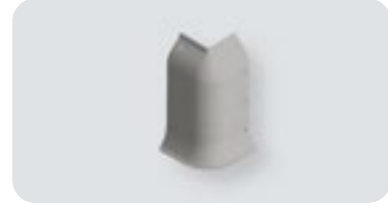
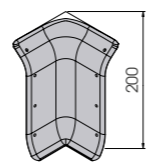

KSE 200

To install with TB14 / TF14

Packing **20 pz / box**
 Colour **B E**

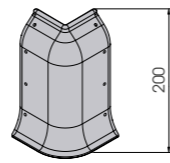

KSTD/SX 200

To install with TB14 / TF14

Packing **20 pz / box**
 Colour **B E**

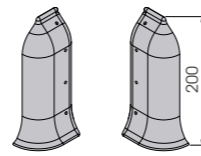

KSJ 200 LT



FLEXIBLE JOINT

Packing **to be defined**
 Colour **K**

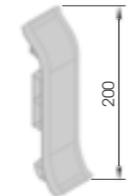

KS 300

Length **4.000 mm**
 Packing **1 pz**
 Colour **M E**

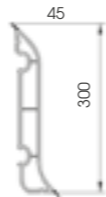

KEPF 300

To install with TB20

Packing **40 pz / box**

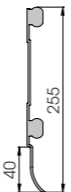

KSJ 300

To install with TB20 / TF20

Packing **10 pz / box**
 Colour **B E**

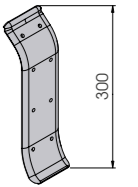

KSI 300

To install with TB20 / TF20

Packing **10 pz / box**
 Colour **B E**

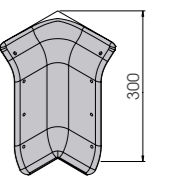

KSE 300

To install with TB20 / TF20

Packing **10 pz / box**
 Colour **B E**

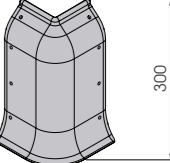

KSTD/SX 300

To install with TB20 / TF20

Packing **10 pz / box**
 Colour **B E**

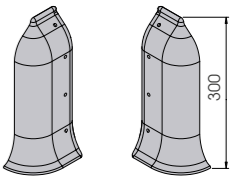

13

WALL PROTECTION

New bumper without guides. Thanks to its big size and resistance it is ideal for protection of industrial spaces. Fixed caps with hidden screws covered by specific buttons.

Nuovo profilo antiurto senza guida. La sua ampiezza e resistenza lo rende ideale per la protezione di ambienti industriali. Terminali fissati con viti nascoste da appositi bottoni.

Nouveau profilé anti-choc sans besoin d'une base à fixer. Sa mesure large et sa résistance en font le profilé parfait pour la protection des espaces industriels. Embouts fixés avec des vis cachées grâce à des bouchons spécifiques.

Nuevo perfil antigolpe sin guía. Su amplitud y resistencia lo hacen ideal para la protección de entornos industriales. Terminales fijados con tornillos ocultos por botones especiales.



Wall Protection

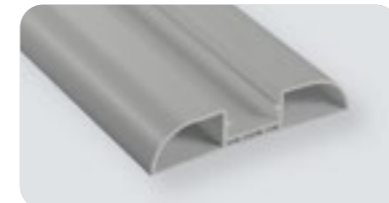

WP 100

Length **4.000 mm**
Packing **8 pz / box**
Colour **B E F**

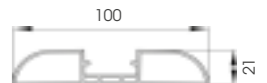

WP 150

Length **4.000 mm**
Packing **4 pz / box**
Colour **B M E**

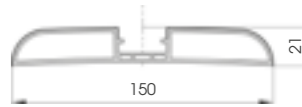

WPC

To install with WP 100 / WP 150

Length **4.000 mm**
Packing **16 pz / box**
Colour **A B M D E F G H**

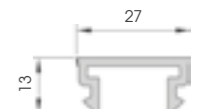

WPT 100

To install with TM5

Packing **50 pz / box**
Colour **B E F**

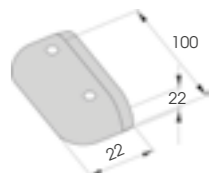

WPA 100

To install with TS9

Packing **20 pz / box**
Colour **B E**

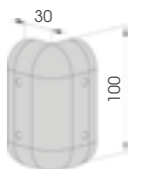

WPT 150

To install with TM5

Packing **50 pz / box**
Colour **B E**

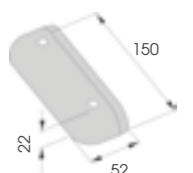

WPA 150

To install with TS9

Packing **20 pz / box**
Colour **B E**

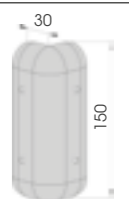

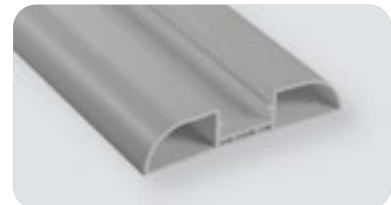
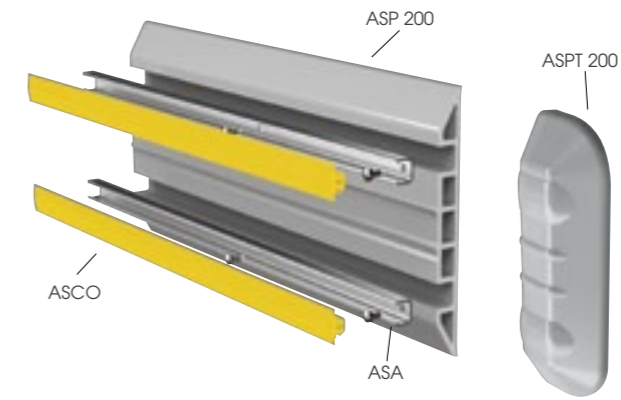
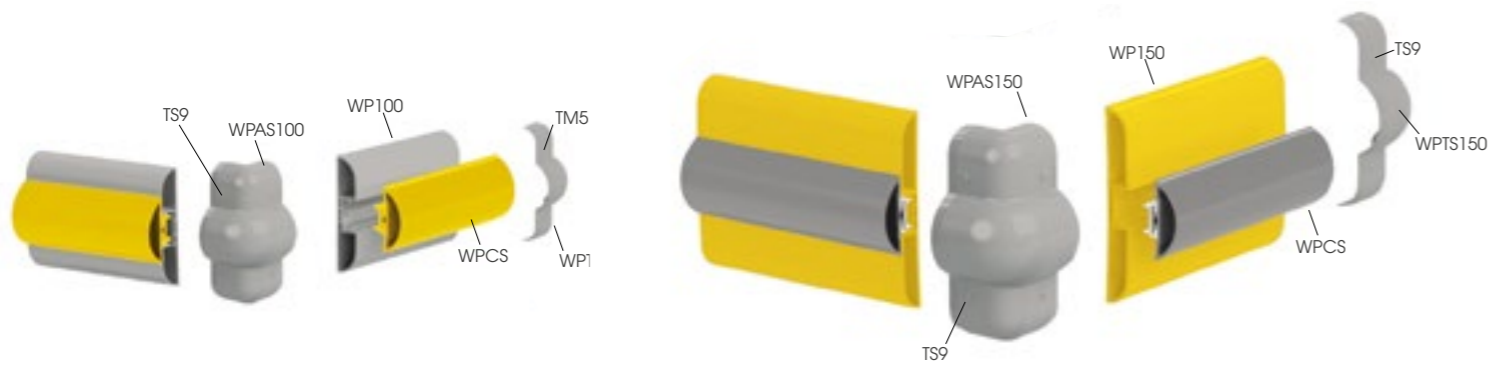

WP 100

Length **4.000 mm**
Packing **8 pz / box**
Colour **B E F**

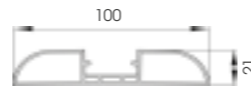

WP 150

Length **4.000 mm**
Packing **4 pz / box**
Colour **B M E**

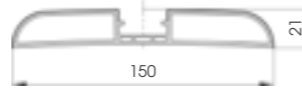

WPCS

To install with WP 100 / WP 150

Length **4.000 mm**
Packing **8 pz / box**
Colour **A B M D E F G H I**

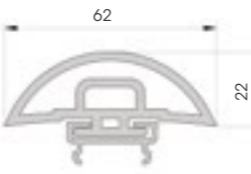

WPTS 100

To install with TS9

Packing **20 pz / box**
Colour **B E**

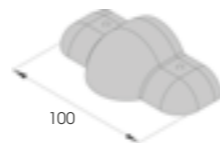

WPAS 100

To install with TS9

Packing **20 pz / box**
Colour **B E**

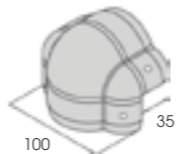

WPTS 150

To install with TS9

Packing **20 pz / box**
Colour **B E**

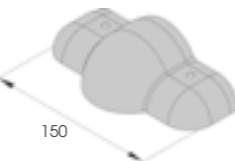

WPAS 150

To install with TS9

Packing **20 pz / box**
Colour **B E**

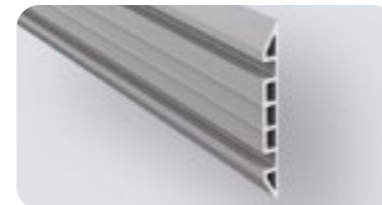
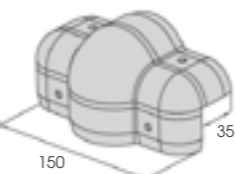

ASP 200



Length **4.000 mm**
Packing **2 pz / box**
Colour **B M**



ASPT 200



Packing **10 pz / box**
Colour **B D**

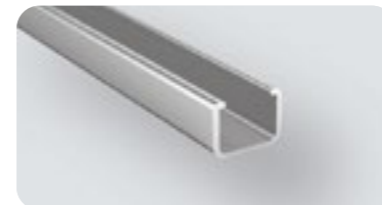
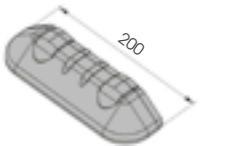

ASA

Material **aluminium**
Length **4.000 mm**
Packing **8 pz / bundle**



ASCO



Packing **2 pz / box**
L = **32.000 mm**
Colour **A B M D G**





WALL HUG 1000
2000
3000
4000

Length 1000/2000/3000/4000
Packing unpacked
Colour M

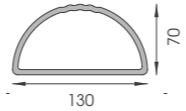

WALL BFLEX 1000
2000
3000
4000

Length 1000/2000/3000/4000
Packing unpacked
Colour M

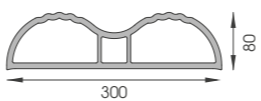

NEWS

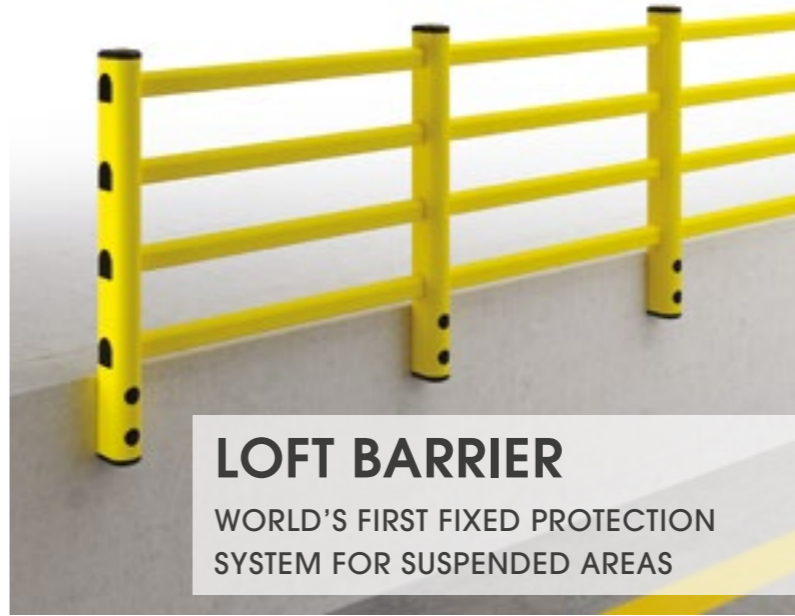

LOFT BARRIER

WORLD'S FIRST FIXED PROTECTION SYSTEM FOR SUSPENDED AREAS

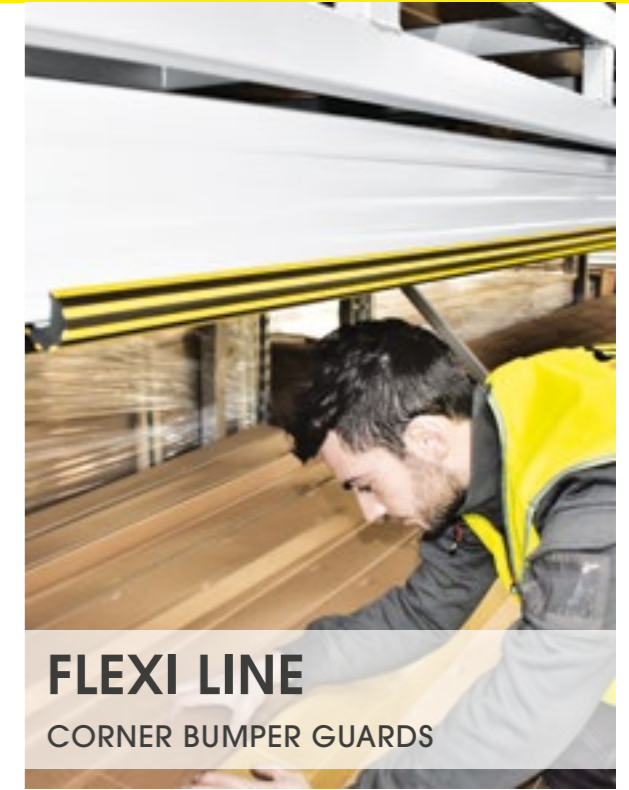

FLEXI LINE

CORNER BUMPER GUARDS



FENCE LINK

THE ADAPTABLE STRONGEST SOLUTION FOR RACK-ENDS

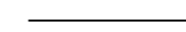

Now available
CUSTOMISED RACK PROTECTOR,
new version of rack protector
processed upon request!

CUSTOMISED RACK PROTECTOR



TM5
Hole required Ø 8.5
Neutral polyethylene. 100/500 Pcs. / bag.



TS9
Hole required Ø 5
White or grey nylon. 1000 Pcs. / bag.



TB14 - TB20
Hole required Ø 4-5
Steel / aluminium (white for Ø 4)
500 Pcs. / box.



TF14 - TF20
Hole required Ø 5-6.5
Aluminium. 500 Pcs. / box.



M12 - M16
HILTI ANCHOR BOLT
Hole required Ø 12-16
Galvanized steel.



S12 - S16
HILTI ANCHOR BOLT
Hole required Ø 10-14
Galvanized steel.



B12 - B16 - B20
HILTI INSERT
Hole required Ø 22-28-32
Galvanized steel.



S12FH
ANCHOR BOLT
Hole required Ø 10
Galvanized steel.



SF12 - SF16 - SF20
Hole required Ø 14-18-24
Stainless steel.



M16 INOX
HILTI INSERT
Hole required Ø 16
Stainless steel.



KIT ROD 70-120 ZINCATA
HILTI INSERT
Hole required Ø 38-56
Galvanized steel.



KIT ROD 70-120 INOX
HILTI INSERT
Hole required Ø 38-56
Galvanized steel.



FR
HILTI CHEMICAL ANCHOR
300 ML



FIX P90
Galvanized steel and painted.



COVER 90 RE
Galvanized steel and painted. 8 Pcs. / box.



FIX P90 INOX
Stainless steel.



FIX P150
Galvanized steel and painted.



COVER 150 RE
Galvanized steel and painted.



FIX P150 INOX
Stainless steel.



FIX P150 FH
Galvanized steel and painted.



FULL FRAME BASE
Galvanized steel and painted.



SHOCK ABSORBER PAD
Soft material, optional for FIXP150.

Colours

A	B	D	E	F	G	H	I	K	L	M
RED RAL 3002	GREY RAL 7040	BLACK RAL 9005	WHITE RAL 9010	WHITE RAL 9002	BLUE RAL 5005	GREEN RAL 6029	SILVER RAL 9006	LIGHT GREY RAL 7035	DARK GREY RAL 7024	LIGHT YELLOW RAL 1018

Cleaner resistant	Cheap	Easy to clean	<input checked="" type="checkbox"/> YES <input type="checkbox"/> NO
Quick assembly	Long resistance	Good thermal insulation	
Shockproof	Good waterproof	Non toxic	Class V0 self-extinguishing fire resistance

MPM srl reserves the right, at any time, to introduce the necessary changes and improvements to its products. Any small imperfection in the products and in the materials used are due to the processing method. Any reproduction of this brochure, even in part, is forbidden.

MPM srl reserves the right, at any time, to introduce the necessary changes and improvements to its products. Any small imperfection in the products and in the materials used are due to the processing method. Any reproduction of this brochure, even in part, is forbidden.



SOME OF OUR REFERENCES



THE WORLD'S TOP **LOGISTICS**
PROFESSIONALS CHOOSE OUR
QUALITY MADE IN ITALY



OUR INSTALLATION

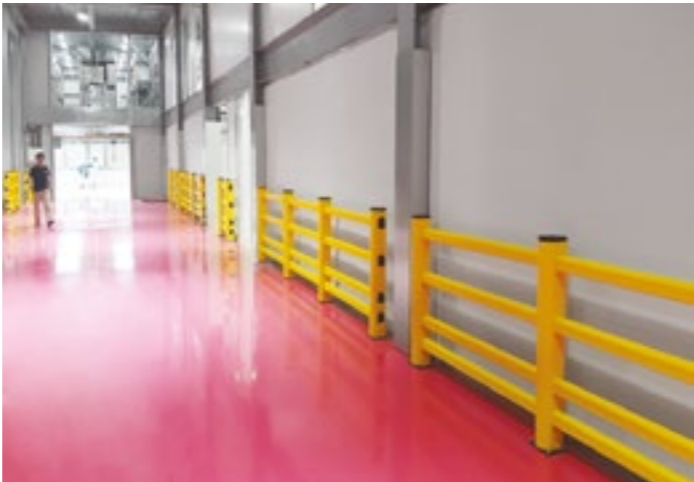

OUR INSTALLATION



MPM states that:

The safety coefficient and consequent use of the product requires preliminary screening by a designer who will necessarily have to take account of the actual installation conditions, considering that instructions contained in catalogues, orders, transport documents, invoices or any other documentation showing the product characteristics, should not be considered suitable to compensate for any lack of design or technical testing required for installation of the product. In any case, it is necessary to comply with the appropriate assembling and installation instructions as defined in the technical catalogue on corporate websites (www.mpmprotections.com). MPM will accept no liability for the use of profiles in situations that have not been preceded by the above-mentioned checks.

Impact forces indicated in the brochure, or in other documents, refer to laboratory tests and cannot take account for consequences determined by installation modes or peculiarities of the place where the products are installed (in an operational environment vehicle type, speed and mass, routes, angles of impact, ground and anchorage are variable and uncontrolled conditions that no test can replicate); the data refers to an intact product that can be affected by alterations from incorrect maintenance and old age, as well as the methods and characteristics of installation (with specific reference to floor-mounted products like the latter); the weight, dimensions, colours and characteristics of the material refer to the sample and the conformity with the latter of the product supplied will be subject to normal production tolerance. The product may be affected by environmental installation conditions.

Protections performances can be affected in environments with temperatures below 0°C or higher than 50°C.

The fastness of the colour and its brightness depend on wear and tear and climatic conditions that can affect its intensity over time.

Images in the brochure are for advertising purposes only and do not in any way represent how the products should be used.

Full version of MPM product warranty available in the technical catalogue on corporate websites (www.mpmprotections.com).





MADE IN
ITALY



M.P.M. s.r.l.
Via Europa 2
35010 Fratte
di S. Giustina in Colle
Padova · Italy

T +39 049 9301773
F +39 049 9300427
info@mpmpvc.com
mpmprotections.com

DISTRIBUTOR OF MPM s.r.l.



SPAN
Abu Dhabi | Beirut | Doha | Dubai | Riyadh

www.span-group.com
E: Inquiry@span-group.com